

STILBY



We shape the space around us.

O NAMA

DODAJTE STIL SVOM PROSTORU

Proizvodimo, uvozimo i distribuiramo dekorativne elemente od polistirena, dizajnirane da transformišu svaki enterijer i eksterijer u savršen spoj estetike i funkcionalnosti.

POUZDAN PARTNER ZA VAŠ PROJEKAT

Više od 300 zadovoljnih klijenata u zemlji i inostranstvu govori u prilog našem kvalitetu i posvećenosti. Naš stručni tim, sa više od 90 zaposlenih, svakodnevno radi na tome da svaki detalj vašeg prostora bude savršen.

PRILAGODITE PROSTOR SVOJIM ŽELJAMA

Uz naš širok asortiman dekorativnih elemenata, pružamo i mogućnost izrade po meri. Bez obzira na to da li se radi o modernim, klasičnim ili potpuno unikatnim zahtevima, mi smo tu da vaše ideje pretvorimo u stvarnost. Takođe, specijalizovani smo i za izradu 3D elemenata, koji vašem prostoru daju jedinstven karakter.

NAŠ KVALITET JE VAŠA GARANCIJA

Sertifikovani prema ISO 9001 standardu, osiguravamo vrhunsku proizvodnju i distribuciju, čineći nas vašim pouzdanim partnerom za vaše projekte.

VAŠ PROSTOR, NAŠ IZAZOV

Preпустite nam da unesemo kreativnost i eleganciju u vaš dom, poslovni prostor ili eksterijer – jer vaš prostor zasluđuje najbolje.



SADRŽAJ



SKENIRAJ ZA CENE

FASADNI DEKORATIVNI ELEMENTI

Fasadne lajsne	4
Okoprozorne fasadne lajsne	6
Okoprozorne utapajuće fasadne lajsne	13
Ivične fasadne lajsne	13
Podprozorske fasadne lajsne	14
Potkrovne fasadne lajsne	18
Deobne fasadne lajsne	20
Fasadni venci	21
Fasadni paneli	24
Nut profili	26
Fasadne lajsne za ramove	26
Prozorske klupice	27
Fasadni ukrasi	28
Fasadne konzole	33
Fasadne kocke	36
Balusteri	38
Fasadni stubovi	40
Fasadni kapiteli	42
Fasadne stope	44
Fasadni pilasteri	46
Primeri prozora	48
Primeri savijanja luka	49

DEKORATIVNI ELEMENTI ZA ENTERIJER

Plafonske lajsne	55
Gravirane lajsne	64
Skrivači rasvete	67
Skrivači karniša	74
Zidne lajsne	77
Zidne panel lajsne	82
Podne lajsne	84
Dekoratívno postolje	88
Ivične lajsne	89
Fleksibilne lajsne	92
Dekoratívni uglovi	96
Ornament uglovi	99
Zidni paneli	100
Zidni paneli sa ramom	113
3D zidne obloge	118
Styro Stone	121
Plafonske obloge i izolacione folije	122
Rozete	124
Stubovi, pilasteri i ukrasi	128
Rustik dizajn	130
Imitacija kamina	132
Žardinjere	134
3D elementi	136
Lepkovi i pribor za montažu	140
Uputstva za montažu	142
Promotívni materijal	146

FASADNI DEKORATIVNI ELEMENTI

- Fasadni dekorativni elementi izrađeni su od tvrdog polistirena jedinstvenom **"PROFESSIONAL" tehnologijom** zaštitnog sloja od kompozitnog maltera u debljini **od 2,5 do 3 mm**

- Debljina kompozitnog maltera daje fasadnim elementima izuzetnu otpornost na mehanička oštećenja i atmosferske uticaje

- Otporni su na upijanje vode i njene neželjene uticaje i imaju potrebnu elastičnost i adheziju na podlogu

- Specijalni završni premaz omogućava dobro prijanjanje svih fasadnih vodorastvorivih boja i daje elementu prirodni izgled

- Poseduju **Sertifikat** koji potvrđuje sve njihove karakteristike

- Standardna dužina fasadnih lajsni je **2500 mm**

JEDINSTVENA
PROFESSIONAL
TEHNOLOGIJA ZAŠTITNOG SLOJA

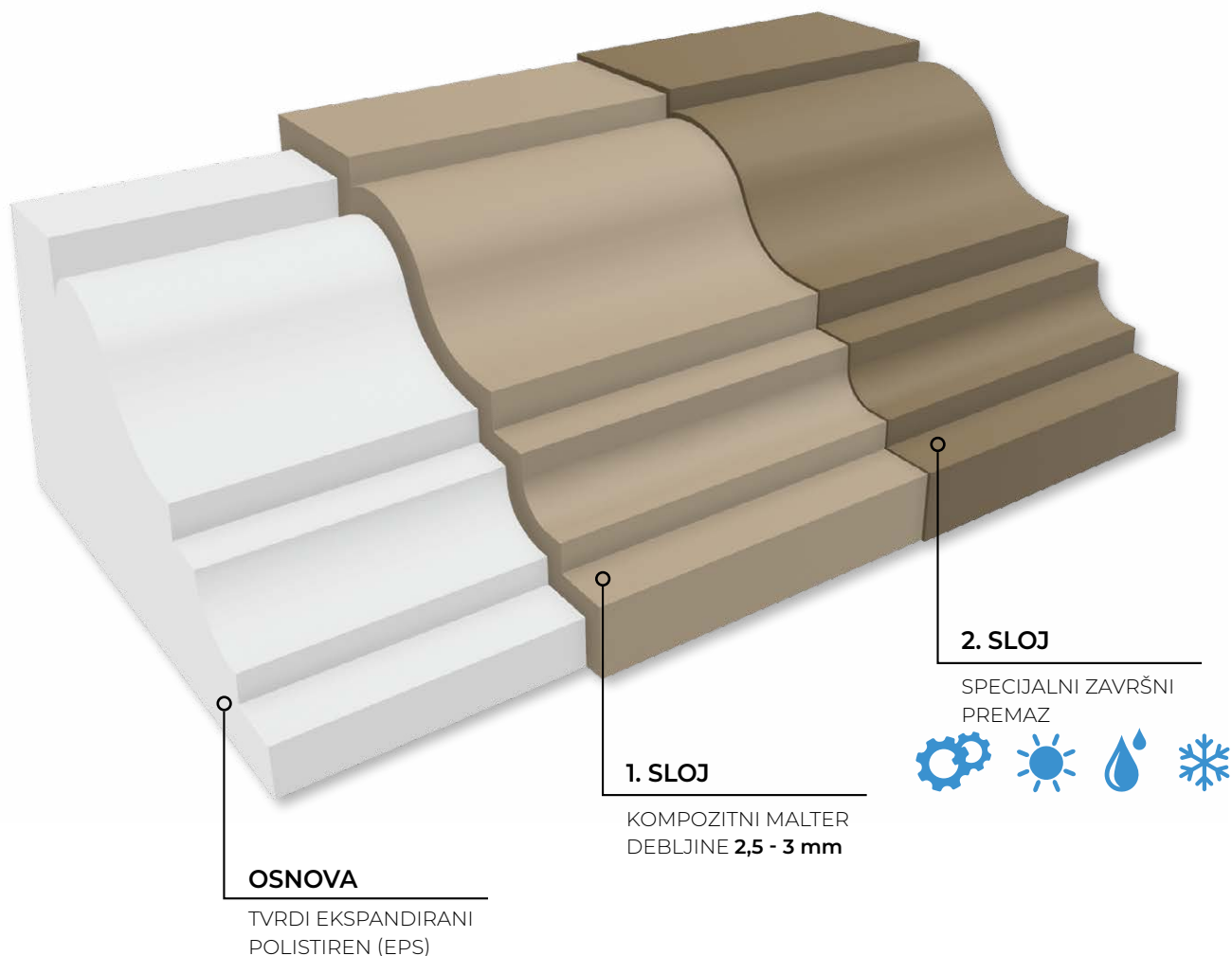

FASADNE LAJSNE

OKOPROZORNE FASADNE LAJSNE

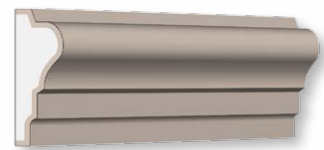

OP 312 A

L 2500 mm

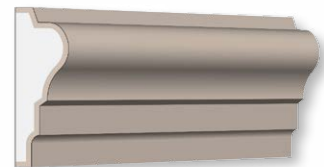

OP 312 B

L 2500 mm

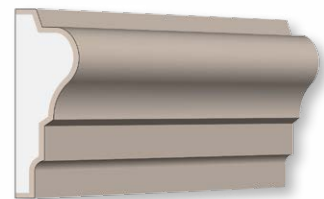

OP 312 C

L 2500 mm





OP 310

L 2500 mm



OP 308

L 2500 mm



OP 309

L 2500 mm



OP 318

L 2500 mm



OP 329

L 2500 mm

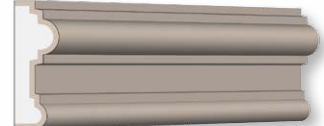

OP 328

L 2500 mm



OP 327

L 2500 mm

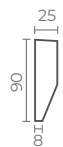

OP 302

L 2500 mm

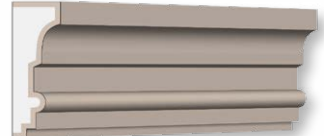
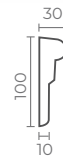

OP 323

L 2500 mm

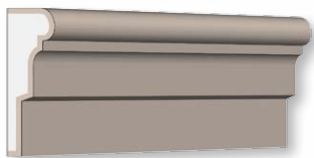

OP 305

L 2500 mm



OP 306 A

L 2500 mm



OP 306 B

L 2500 mm

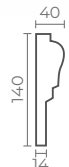

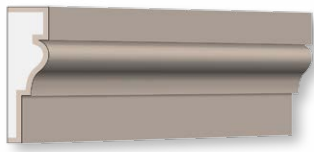

OP 301 A

L 2500 mm

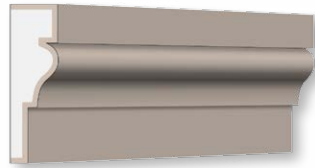

OP 301 B

L 2500 mm

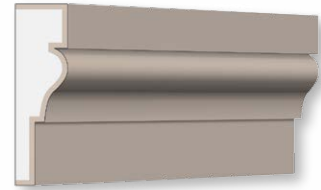

OP 301 C

L 2500 mm

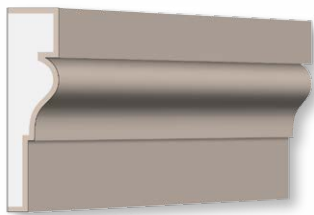

OP 301 D

L 2500 mm

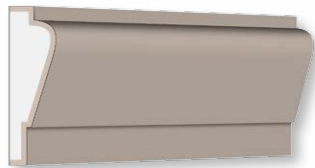

OP 326

L 2500 mm

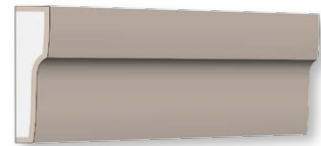

OP 333

L 2500 mm

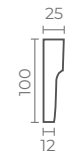

OP 316 A

L 2500 mm

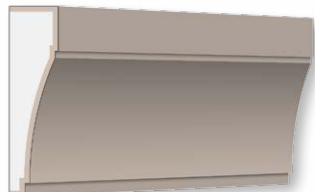

OP 316 B

L 2500 mm

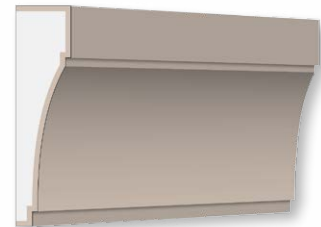

OP 316 C

L 2500 mm

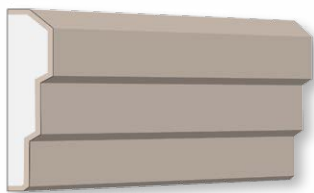

OP 311 A

L 2500 mm

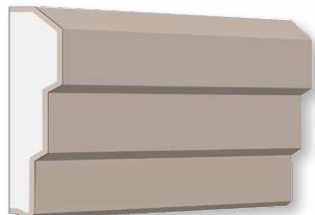
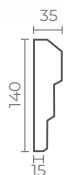

OP 311 B

L 2500 mm

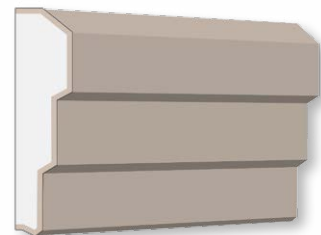

OP 311 C

L 2500 mm



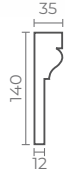
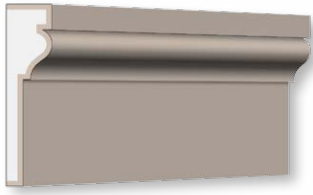

OP 304 A

L 2500 mm

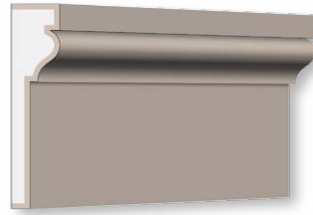

OP 304 B

L 2500 mm

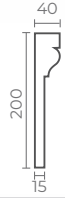
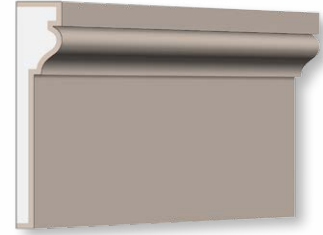

OP 304 C

L 2500 mm

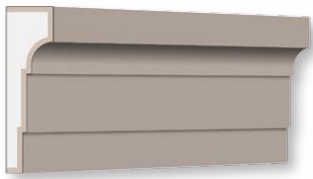

OP 303 A

L 2500 mm

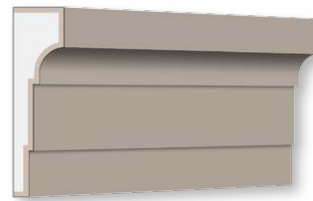

OP 303 B

L 2500 mm

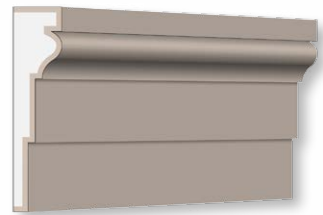

OP 307

L 2500 mm

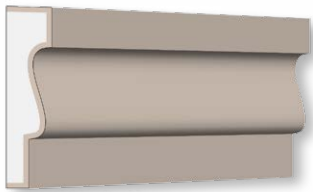

OP 315

L 2500 mm



OP 319 A

L 2500 mm

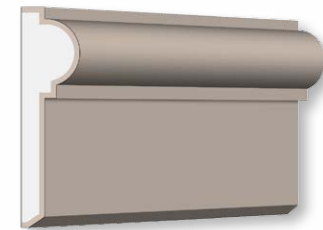

OP 319 B

L 2500 mm

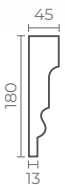
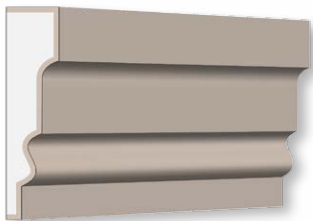

OP 355

L 2500 mm

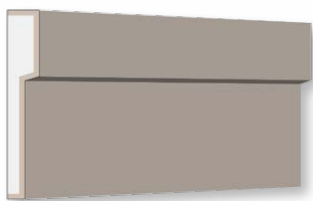

OP 335 A

L 2500 mm

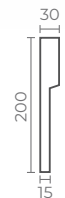
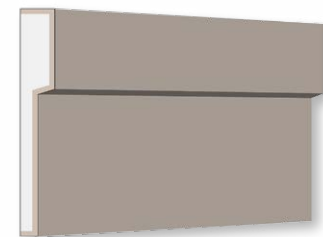

OP 335 B

L 2500 mm

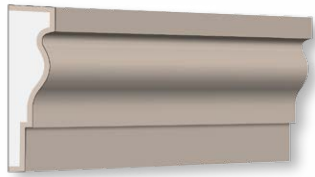

OP 314

L 2500 mm



OP 401

L 2500 mm

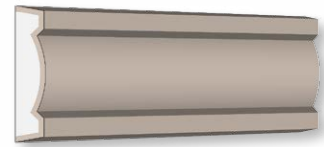

OP 422

L 2500 mm

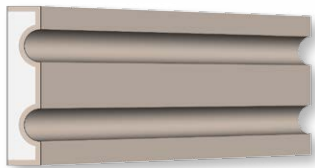

OP 430

L 2500 mm



OP 420

L 2500 mm

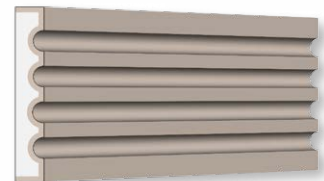

OP 419

L 2500 mm

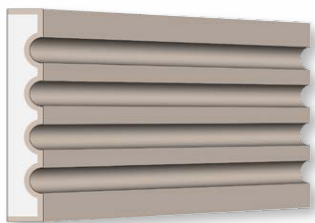

OP 423

L 2500 mm

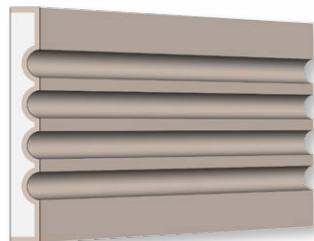

OP 428

L 2500 mm

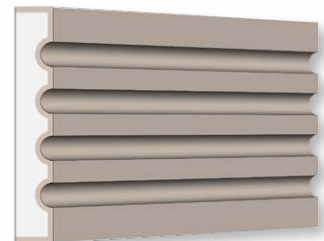

OP 425

L 2500 mm

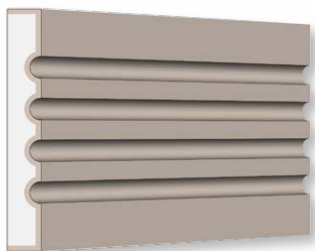

OP 429

L 2500 mm

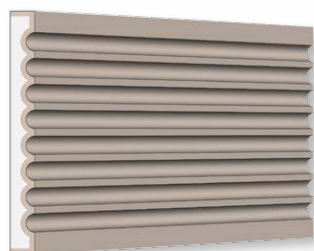

OP 426

L 2500 mm





RS 60

L 2500 mm



RS 80

L 2500 mm



RS 100

L 2500 mm



RS 120

L 2500 mm

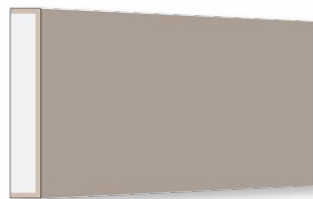

RS 150

L 2500 mm

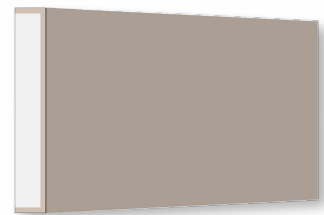

RS 180

L 2500 mm



RS 200

L 2500 mm



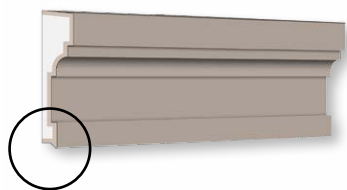

OP 322 A

L 2500 mm

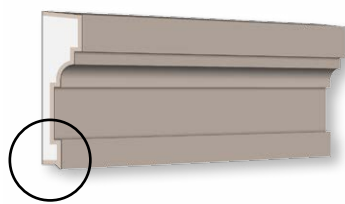

OP 322 B

L 2500 mm

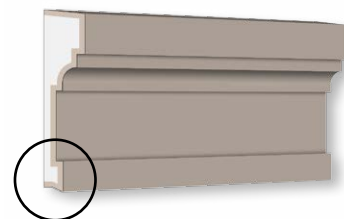

OP 322 C

L 2500 mm

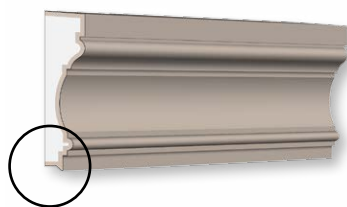

OP 324

L 2500 mm

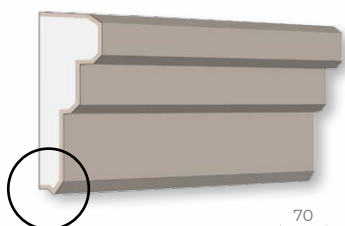

OP 325

L 2500 mm

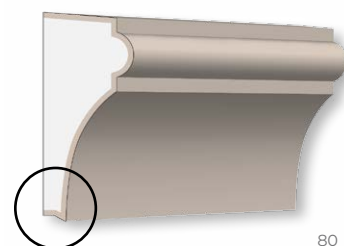

OP 330

L 2500 mm

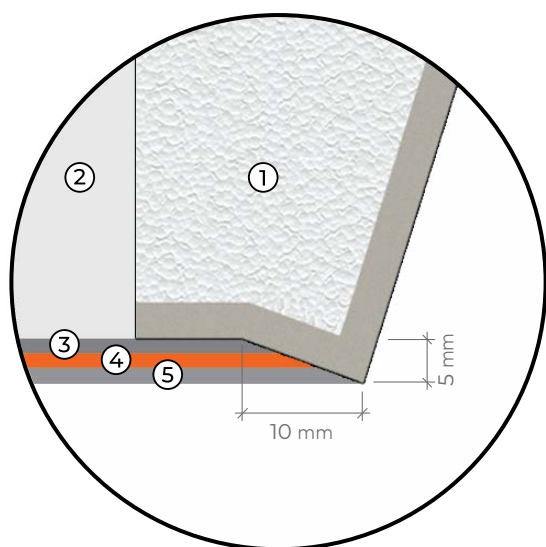

- ① OKOPROZORNA FASADNA LAJSNA
- ② ZIDNA POVRŠINA
- ③ SLOJ LEPKA ZA LEPLJENJE ZAŠTITNE MREŽICE
- ④ ZAŠTITNA MREŽICA ZA ARMIRANJE
- ⑤ SLOJ CEMENTNOG LEPKA

* OLAKŠAVA OBRADU
ŠPALETNI

OKOPROZORNE UTAPAJUĆE FASADNE LAJSNE

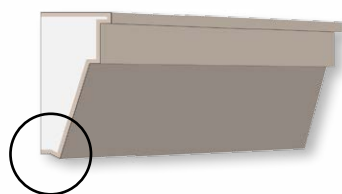

OU 320 A

L 2500 mm

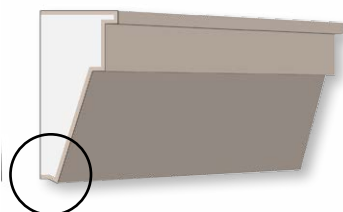

OU 320 B

L 2500 mm

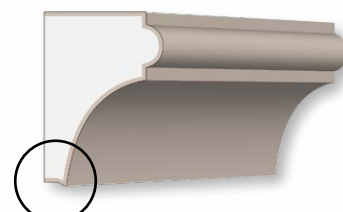

OU 321

L 2500 mm

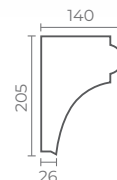

IVIČNE FASADNE LAJSNE



UL 930

L 2000 mm

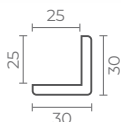

UL 960

L 2500 mm

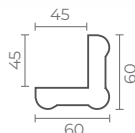

PODPROZORSKE FASADNE LAJSNE



PP 502

L 2500 mm

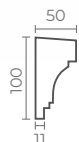

PP 510 A

L 2500 mm

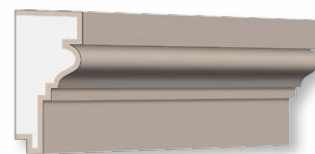
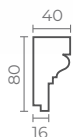

PP 510 B

L 2500 mm



PP 550

L 2500 mm

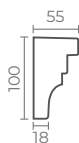

PP 505 A

L 2500 mm

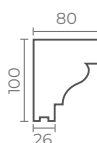

PP 505 B

L 2500 mm

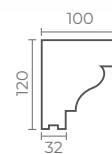

PP 508 A

L 2500 mm



PP 508 B

L 2500 mm



PP 508 C

L 2500 mm

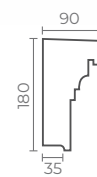

PP 515 A

L 2500 mm

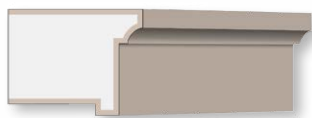
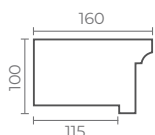

PP 515 B

L 2500 mm

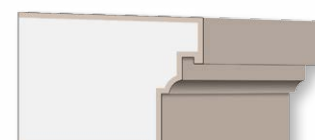
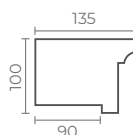

PP 515 C

L 2500 mm

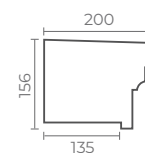

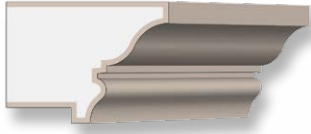

PP 503

L 2500 mm

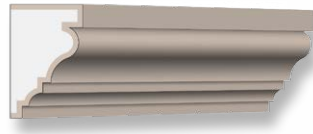
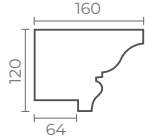

PP 509 A

L 2500 mm

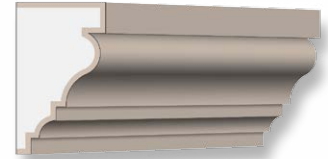

PP 509 B

L 2500 mm

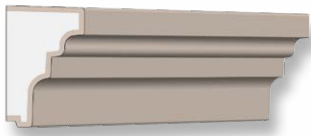
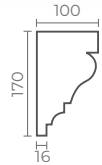

PP 548

L 2500 mm

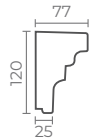

PP 501 A

L 2500 mm

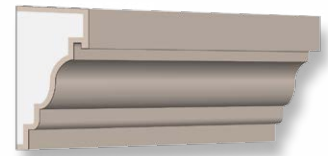
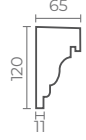

PP 501 B

L 2500 mm

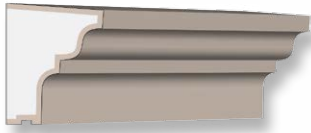
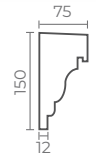

PP 554

L 2500 mm

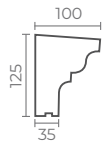

PP 555

L 2500 mm

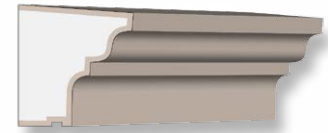
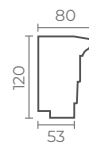

PP 574

L 2500 mm

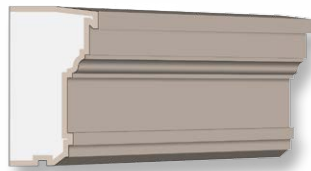
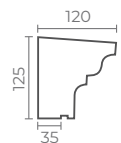

PP 556 A

L 2500 mm

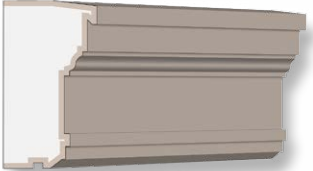

PP 556 B

L 2500 mm

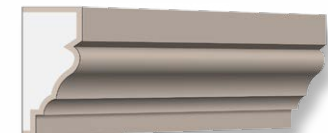
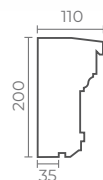

PP 504

L 2500 mm

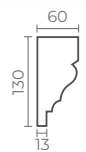

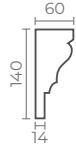
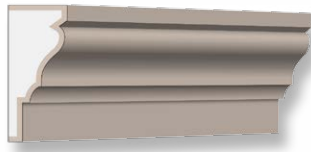

PP 506 A

L 2500 mm

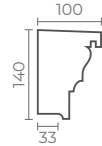
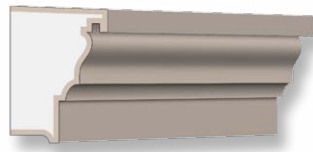

PP 506 B

L 2500 mm

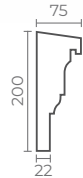
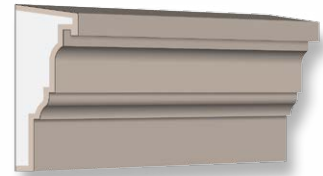

PP 513

L 2500 mm



PP 507 A

L 2500 mm

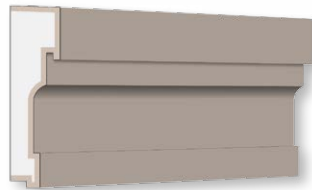

PP 507 B

L 2500 mm

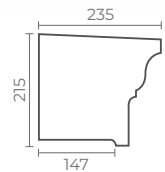
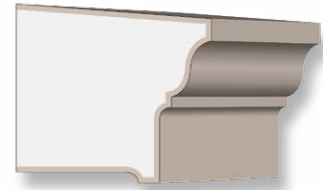

PP 524

L 2500 mm

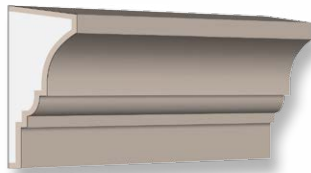

PP 514

L 2500 mm

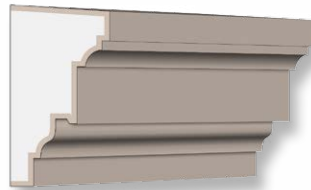

PP 511

L 2500 mm

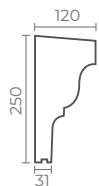
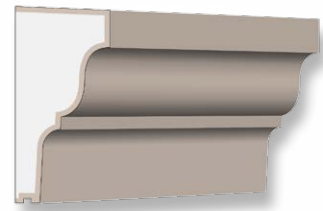

PP 512

L 2500 mm



POTKROVNE FASADNE LAJSNE

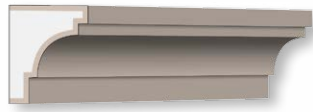

PP 542

L 2500 mm

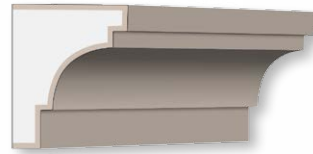
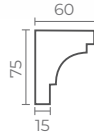

PK 641

L 2500 mm

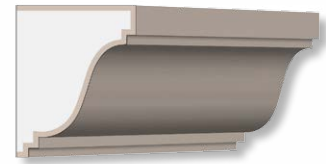
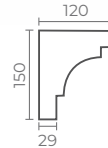

PK 675

L 2500 mm

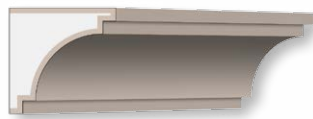
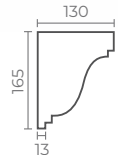

PK 611 A

L 2500 mm

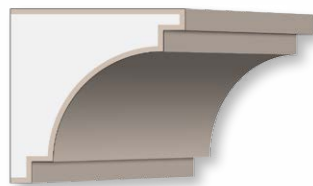
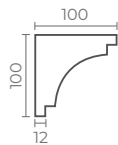

PK 611 B

L 2500 mm

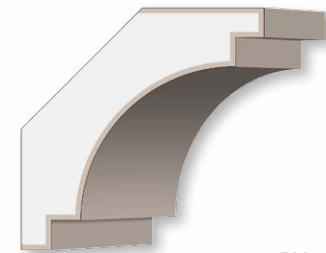
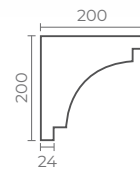

PK 611 C

L 2500 mm

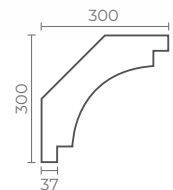

PK 612 A

L 2500 mm

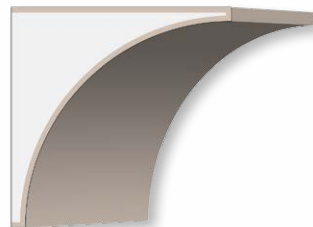
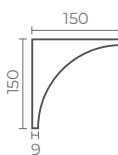

PK 612 B

L 2500 mm

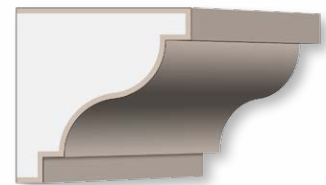
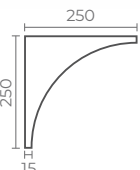

PK 609

L 2500 mm

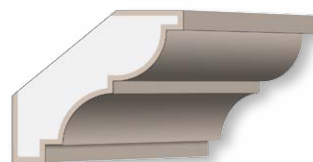
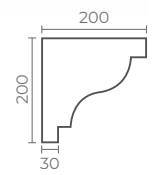

PK 710 A

L 2500 mm

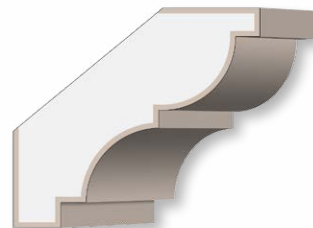
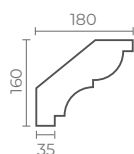

PK 710 B

L 2500 mm

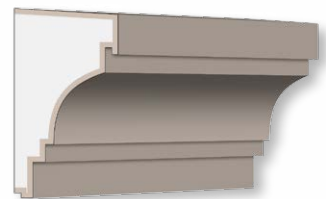
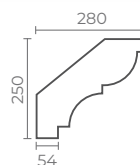

PK 608

L 2500 mm

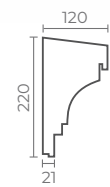

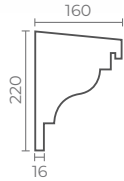
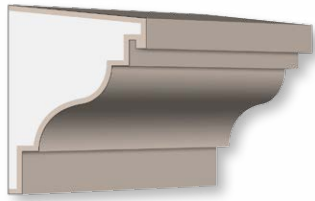

PK 603

L 2500 mm

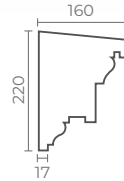
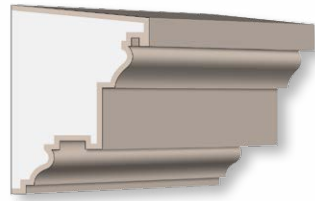

PK 601

L 2500 mm

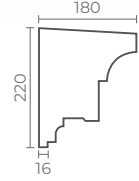
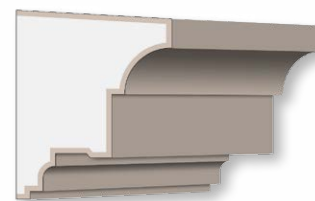

PK 602

L 2500 mm

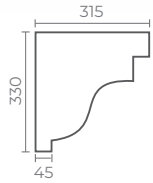
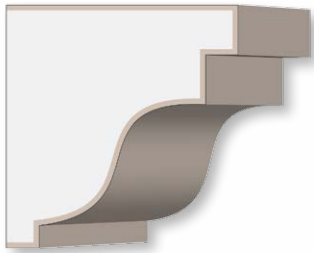

PK 610

L 2500 mm



DEOBNE FASADNE LAJSNE



VA 525 A

L 2000 mm

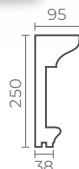
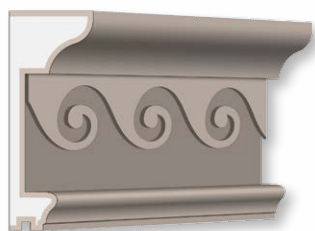

VA 525 B

L 2000 mm

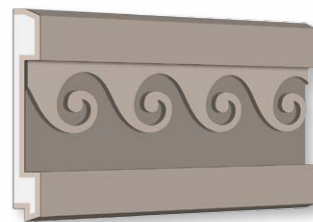

DP 803

L 2000 mm

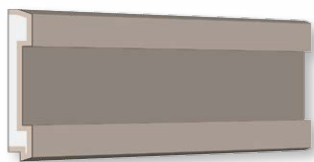

DP 801

L 2500 mm

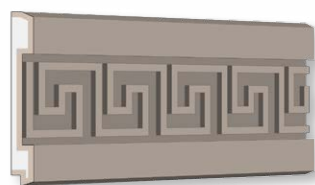

DP 804 A

L 2000 mm

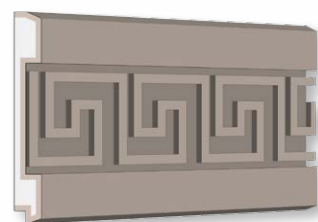

DP 804 B

L 2000 mm



DP 806

L 2500 mm



GR 526 A

L 2000 mm

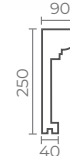

GR 526 B

L 2000 mm

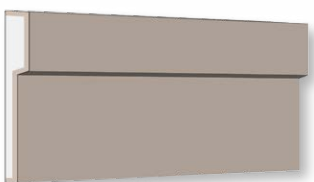

DP 802

L 2500 mm

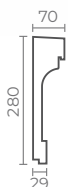
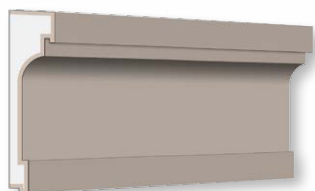

DP 805 A

L 2500 mm

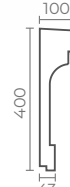
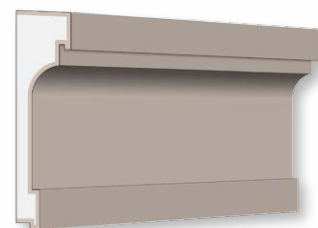

DP 805 B

L 2500 mm

FASADNI VENCI



ZU 2

L 2000 mm

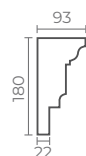
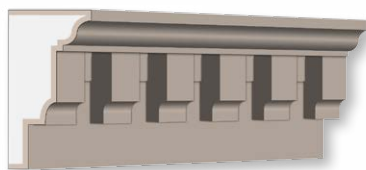

ZU 1

L 2000 mm

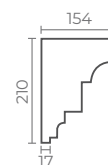
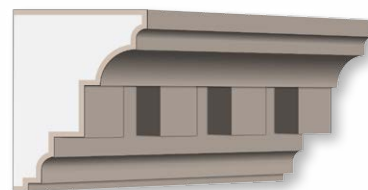

ZU 3

L 2000 mm

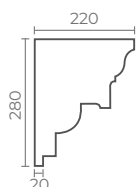
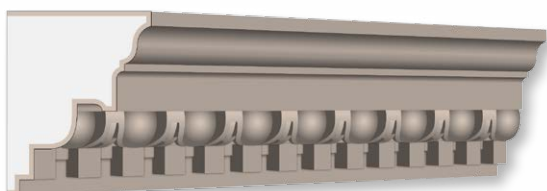

PK 202

L 2000 mm

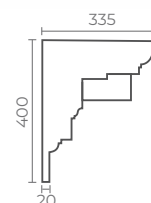
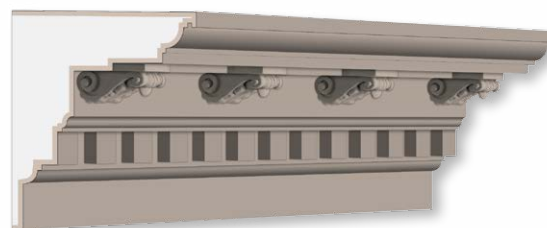

PK 203

L 2500 mm

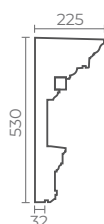
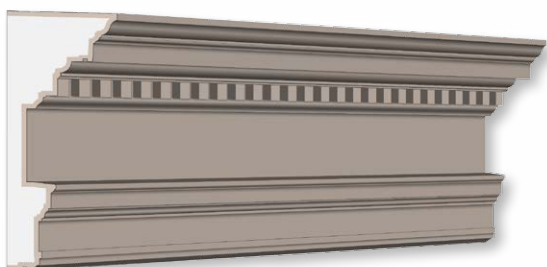

PK 205

L 2500 mm

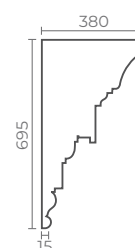
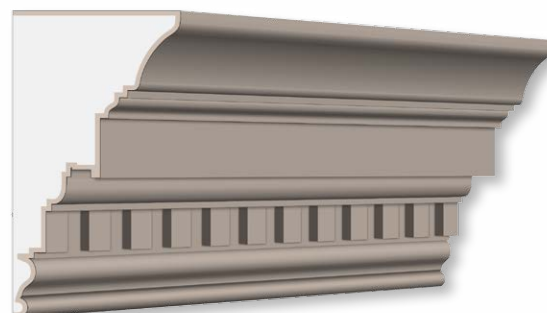

PK 207

L 2500 mm

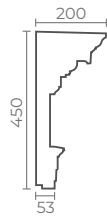

PK 204

L 2500 mm

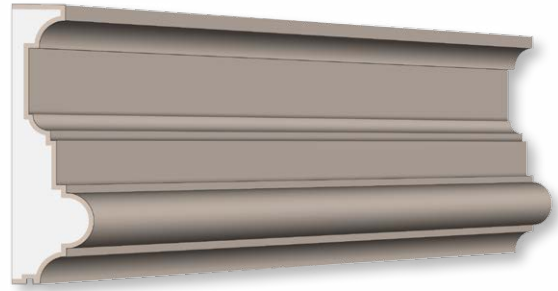

PK 206

L 2500 mm





FASADNI PANELI

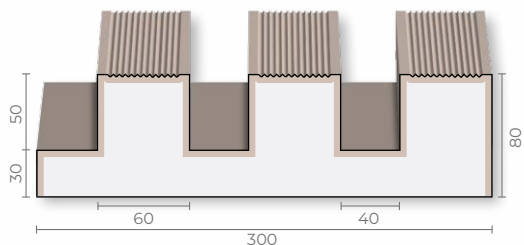

LINES XL

L 2800 mm

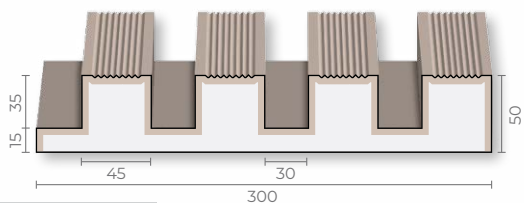

LINES M

L 2800 mm

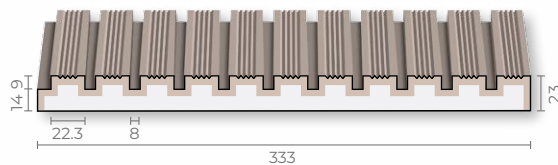

LINES

L 2500 mm

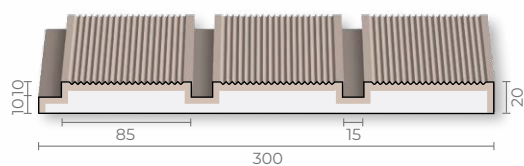

DEKING

L 2500 mm

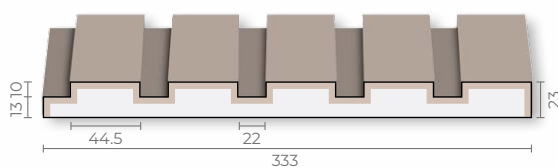

FLAT

L 2500 mm

NAPOMENA: Ugradnja zidnih panela zahteva idealno ravnu površinu zida

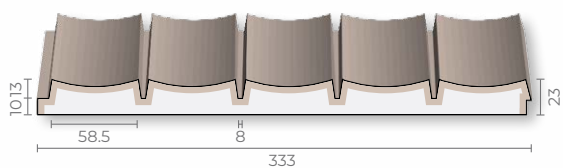

MODERN

L 2500 mm

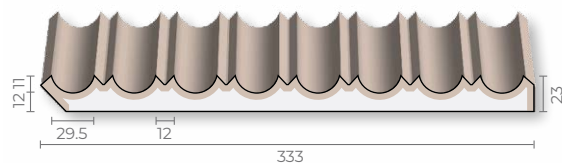

VALE

L 2500 mm

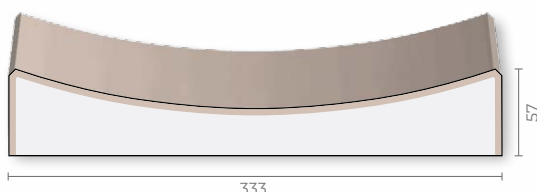

CAVETTO

L 2800 mm

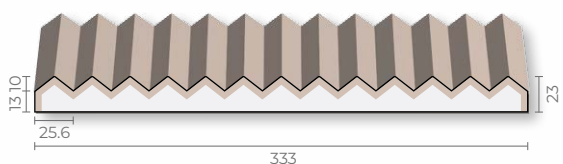

CIK-CAK

L 2500 mm

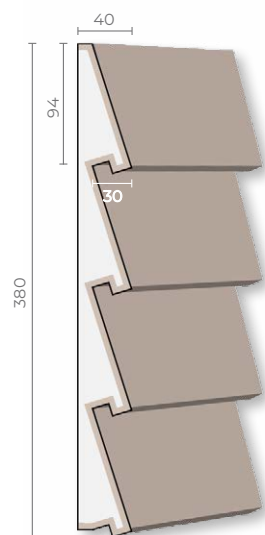

SLASH

L 2500 mm

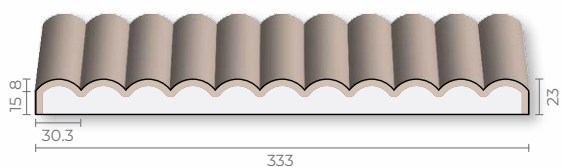

BENDS

L 2500 mm

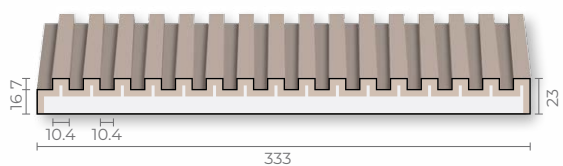

RIBS

L 2500 mm

ZAVRŠNA LAJSNA ZA ZIDNE PANELE

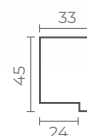

ZA 40

L 2500 mm

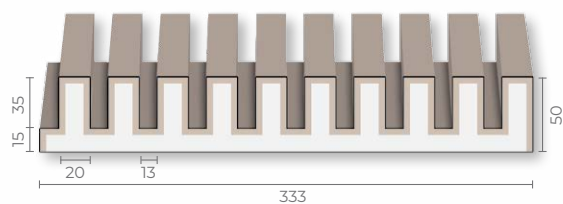

RIBS M

L 2800 mm

NUT PROFILI

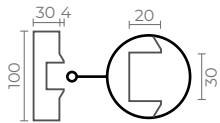
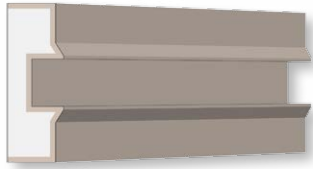

NUT 1

L 2500 mm

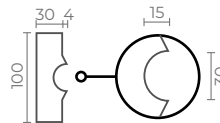
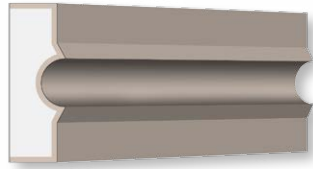

NUT 2

L 2500 mm

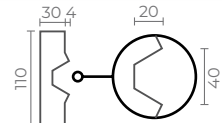
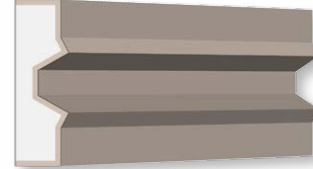

NUT 3

L 2500 mm

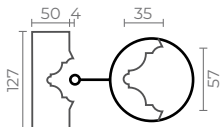
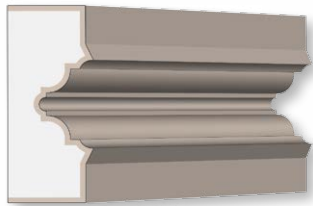

NUT 4

L 2500 mm

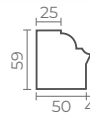

NUT 4 1/2

L 2500 mm

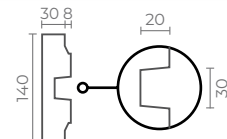
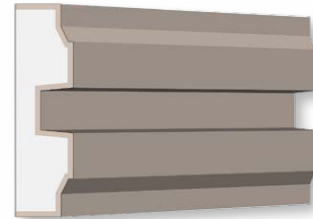

NUT 5

L 2500 mm

FASADNE LAJSNE ZA RAMOVE

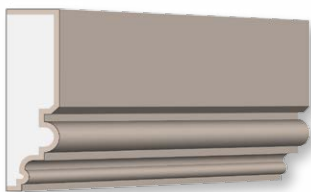

RA 01

L 2500 mm



RA 02

L 2500 mm

PROZORSKE KLUPICE

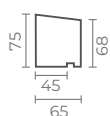
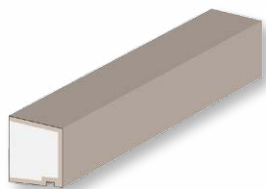

PKL 65

L 2000 mm/2500 mm

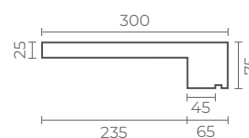
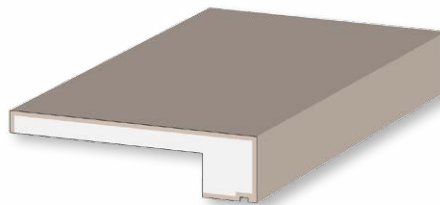

PKL 300

L 1200 mm/1500 mm/1800 mm/2000 mm/2500 mm

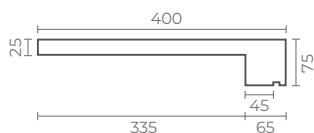
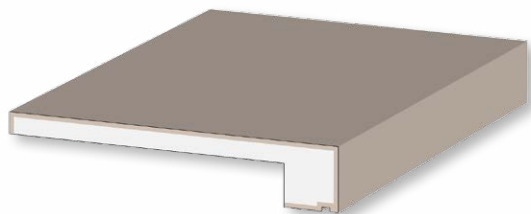

PKL 400

L 1200 mm/1500 mm/1800 mm/2000 mm/2500 mm



PKL 500

L 1200 mm/1500 mm/1800 mm/2000 mm/2500 mm



FASADNI UKRASI

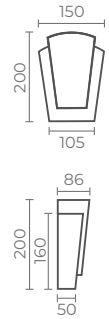

UK 1

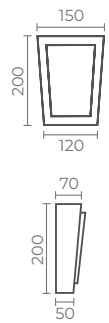

UK 2

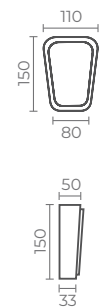

UK 3

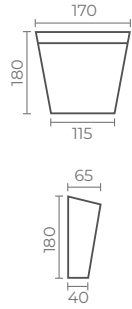

UK 7

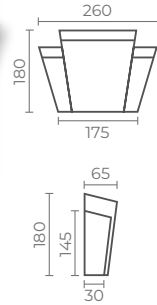

UK 8

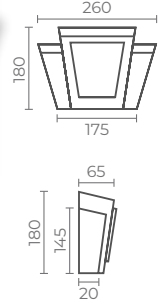

UK 9

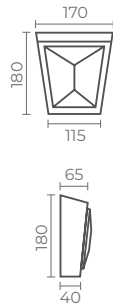

UK 10

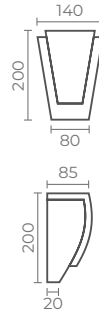

UK 28

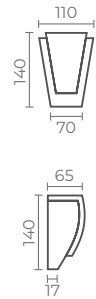

UK 29

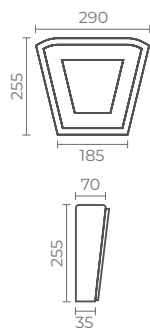

UK 25

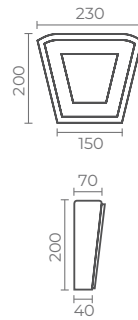

UK 26

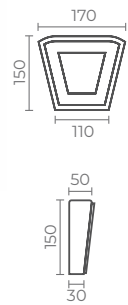

UK 27

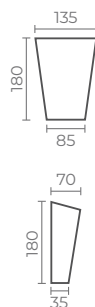

UK 31

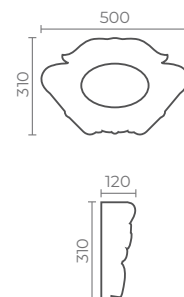

UK 37

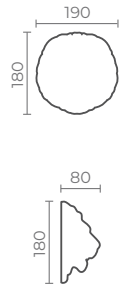

LION



LION A

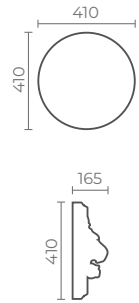

LION B

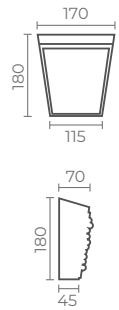

UK 22



UK 20

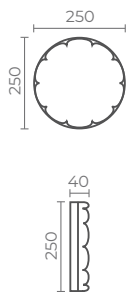

UK 20 A

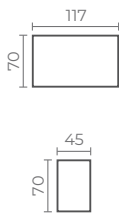

UK 5

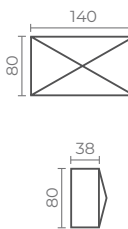

UK 6

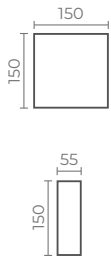

UK 39

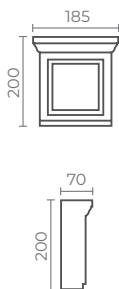

UK 33

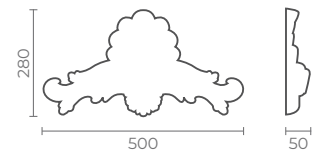

UK 24

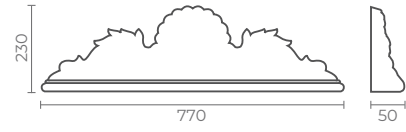

UK 41

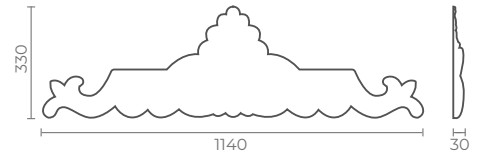

UK 42

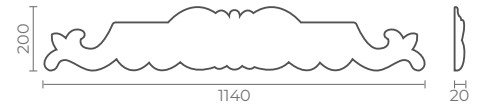

UK 43

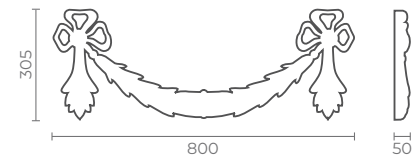

LIST-MAŠNA A

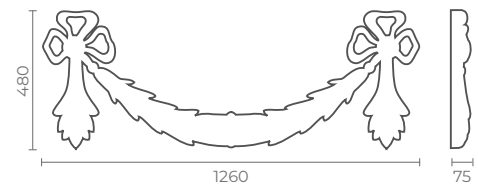

LIST-MAŠNA B



UK 40 A

UK 40

UK 40 A

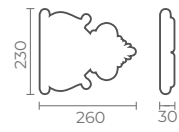
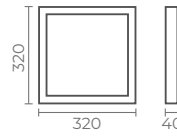

Napomena: svaki segment se prodaje posebno

UK 40

UK 40 A



FASADNE KONZOLE

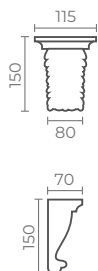

UK 18



UK 47



UK 36



UK 19



UK 32

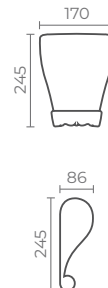

UK 15

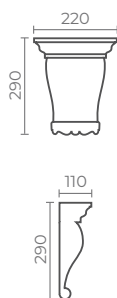

UK 35

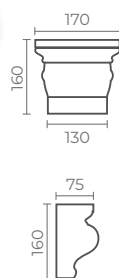

UK 14

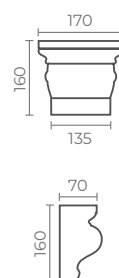

UK 34

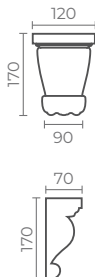

UK VESNA

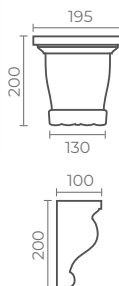

UK VANNA

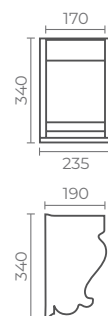

UK 17

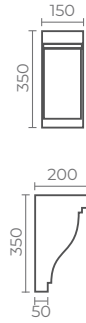
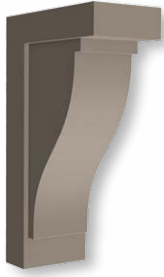

CS 1

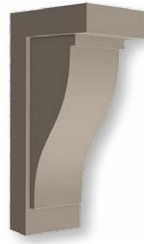

CS 2

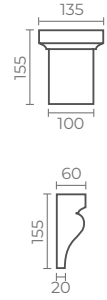

CS 5

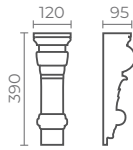

UK 48

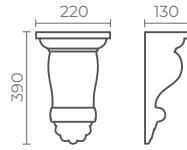

UK 12

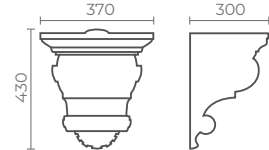

UK 16



UK 38

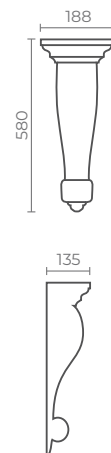

UK 13

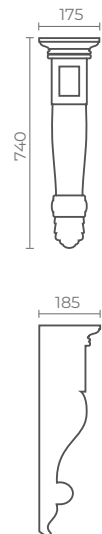

UK 44



FASADNE KOCKE

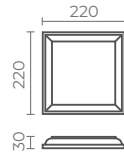

KS 101

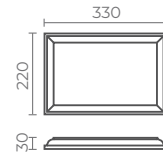
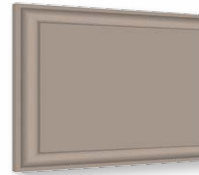

KS 102

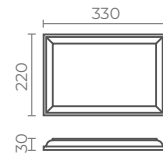
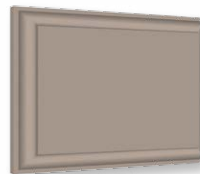

KS 102

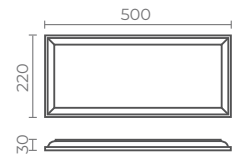

KS 123

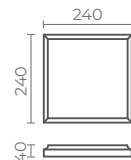

KS 103

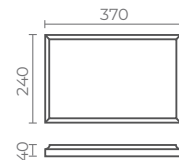
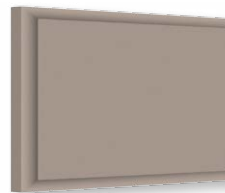

KS 104

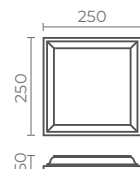

KS 115

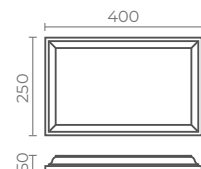

KS 116

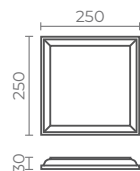

KS 117

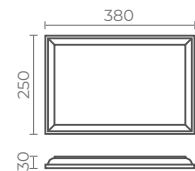
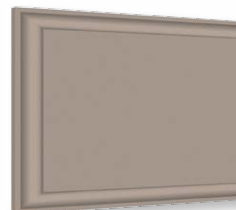

KS 118

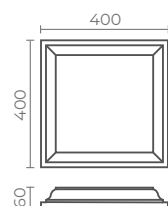

KS 113

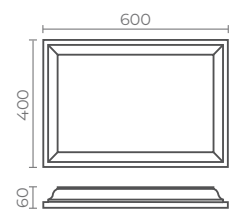

KS 114

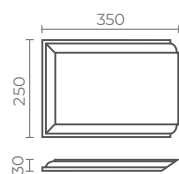
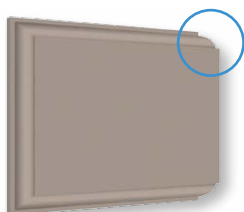

KS 111

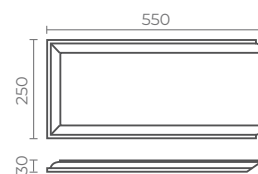

KS 112

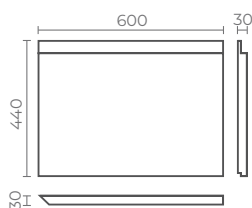
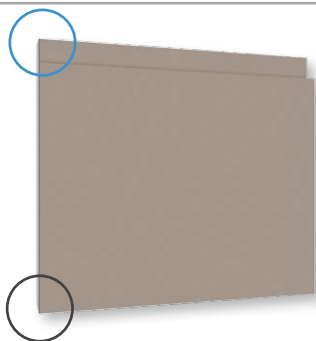

KS 106 L

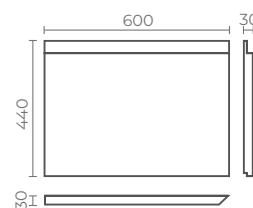
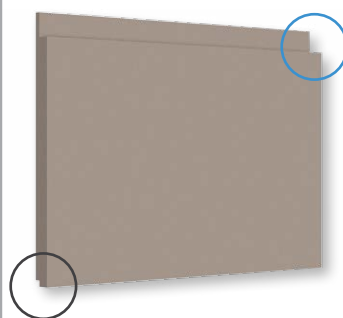

KS 106 R

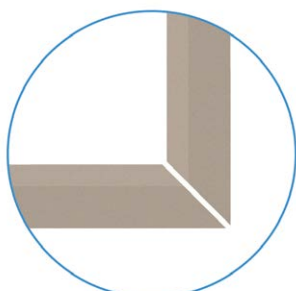

DETALJ SPAJANJA
DVE KOCKE



DETALJ UKLAPANJA KOCKI
KS 106 L / KS 106 R

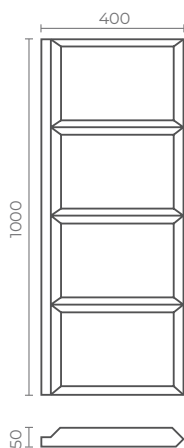

KS 105



BALUSTERI

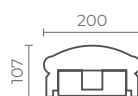
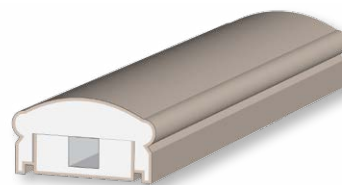

RUKOHVAT
OGRADE
RO



STUB
OGRADE
SO 1

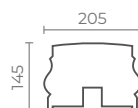
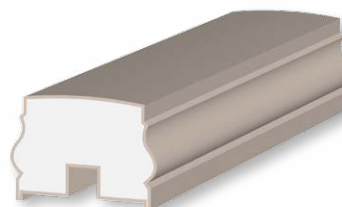

POSTOLJE
OGRADE
PO

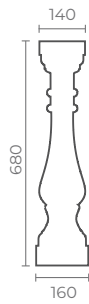

BO 01

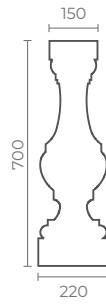

BO 02

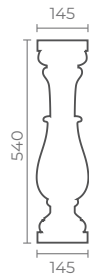

BO 03

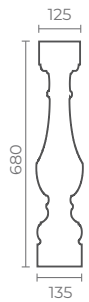

BO 04

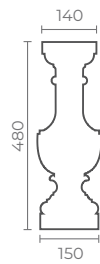

BO 05

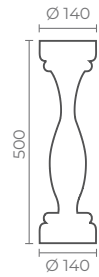

BO 06

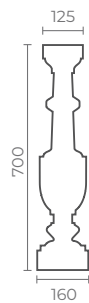

BO 07

ŠEMATSKI PRIKAZ POSTAVLJANJA OGRADE

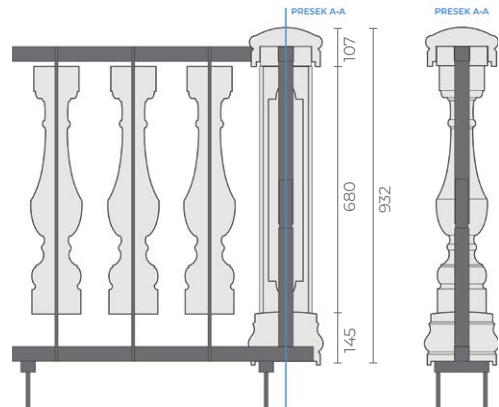
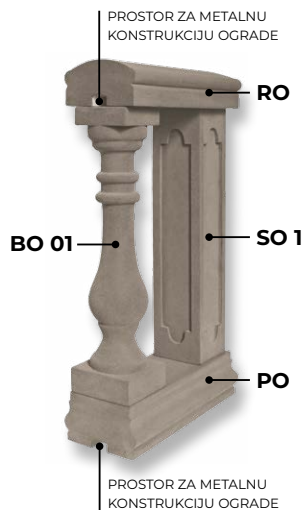

* UZ PROIZVOD NIJE UKLJUČENA METALNA KONSTRUKCIJA

FASADNI STUBOVI

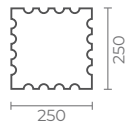
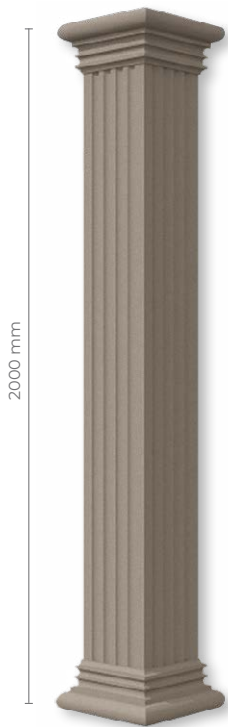

MODEL 1

SASTAVNI ELEMENTI:

Kapitel ST 19
Stub SF 16
Stopa ST 19

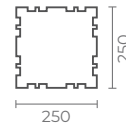
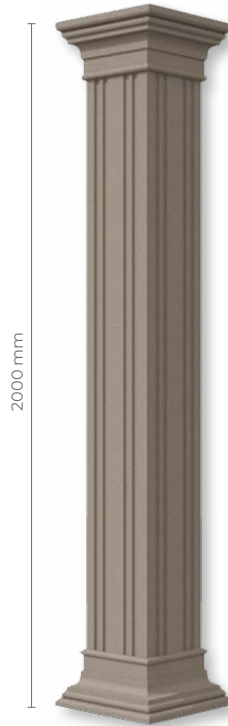

MODEL 2

SASTAVNI ELEMENTI:

Kapitel ST 18
Stub SE 16
Stopa ST 18

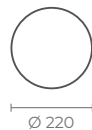

MODEL 3

SASTAVNI ELEMENTI:

Kapitel KP 12
Stub SC 0
Stopa ST 1

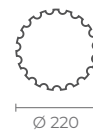
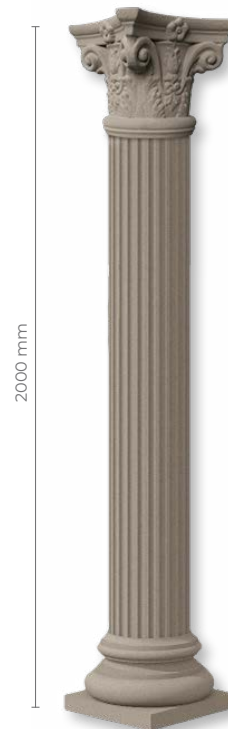

MODEL 4

SASTAVNI ELEMENTI:

Kapitel KP 11
Stub SA 19
Stopa ST 5
Postolje

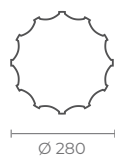
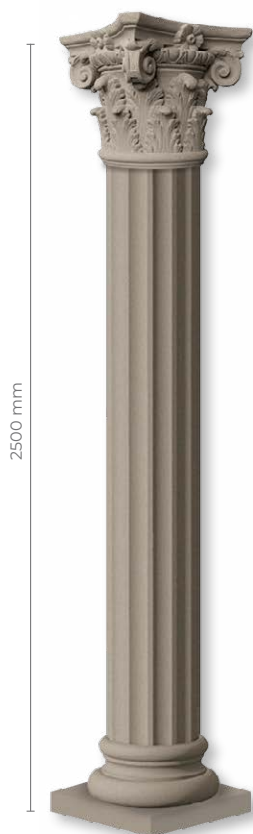

MODEL 5

SASTAVNI ELEMENTI:

Kapitel KP 14
 Stub SD 12
 Stopa ST 6
 Postolje

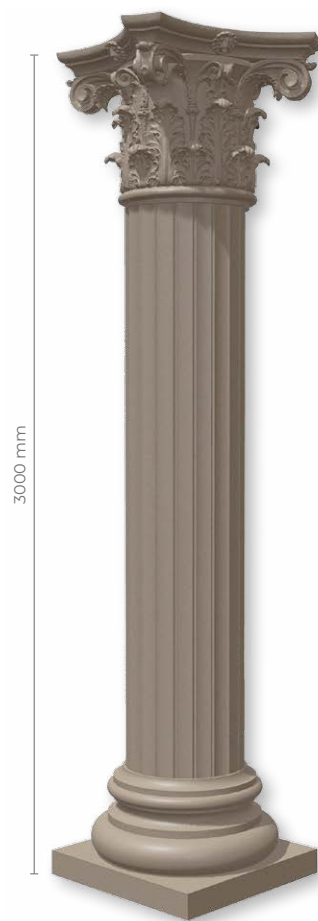

MODEL 6

SASTAVNI ELEMENTI:

Kapitel KP 19
 Stub SD 20
 Stopa ST 20
 Postolje



MODEL 7

SASTAVNI ELEMENTI:

Kapitel KP 11
 Stub KO 0
 Stopa ST 6
 Postolje

Napomena: moguća izrada kanelura na površini stuba

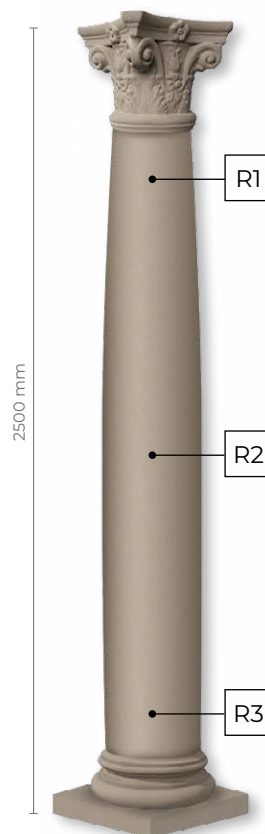

MODEL 8

SASTAVNI ELEMENTI:

Kapitel KP 11
 Stub RA 0
 Stopa ST 5
 Postolje

Napomena: moguća izrada samo glatkog stuba

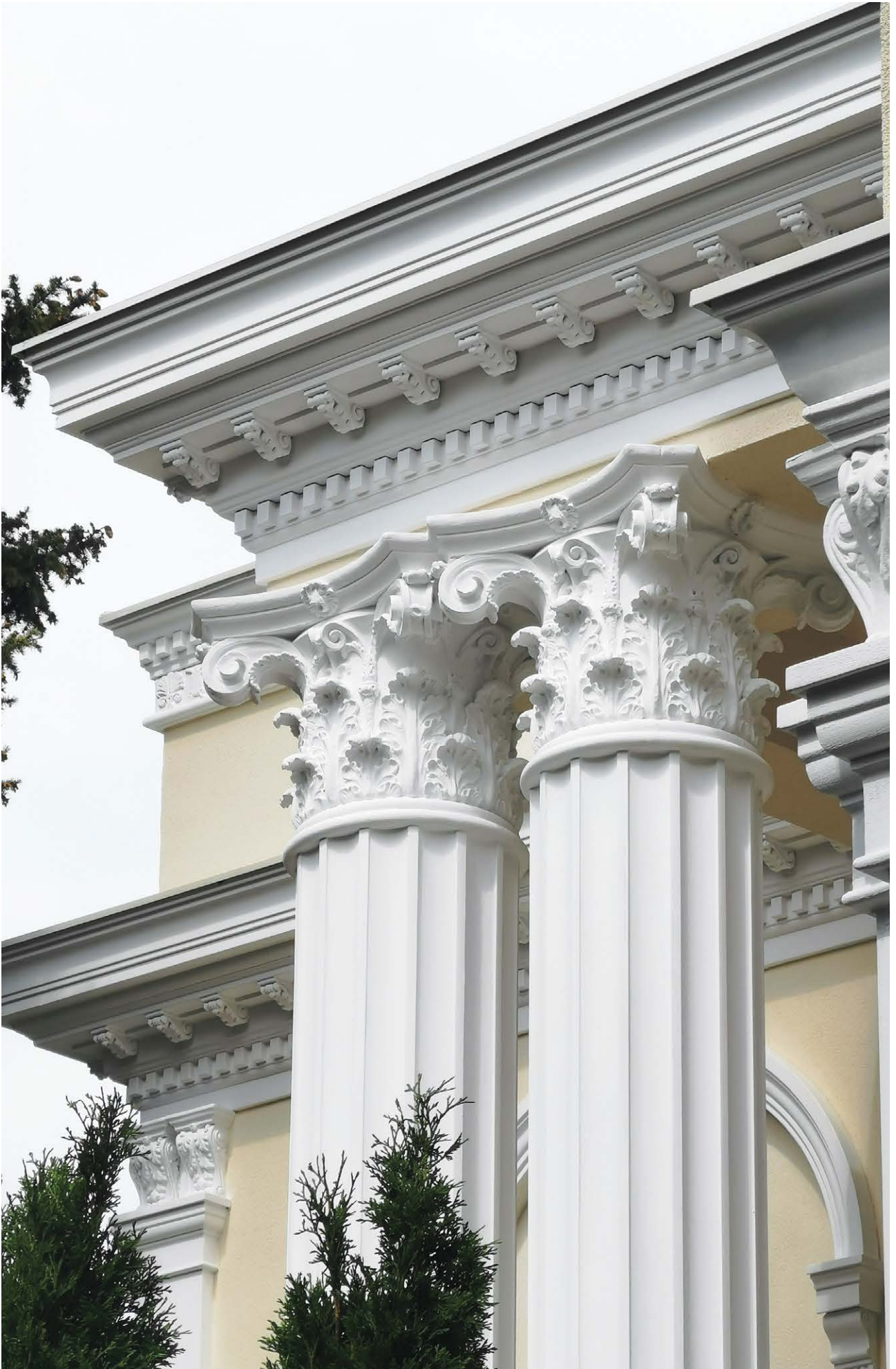

FASADNI KAPITELI

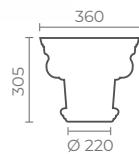

KP 11

Kapitel za stub \varnothing 220 mm

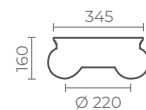

KP 12

Kapitel za stub \varnothing 220 mm

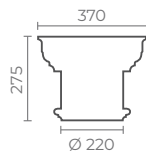

KP 13

Kapitel za stub \varnothing 220 mm

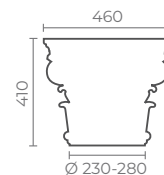

KP 14

Kapitel za stub \varnothing 230-280 mm

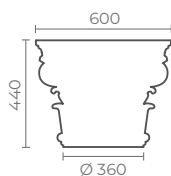

KP 18

Kapitel za stub \varnothing 360 mm

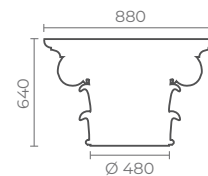

KP 19

Kapitel za stub \varnothing 480 mm

FASADNE STOPE

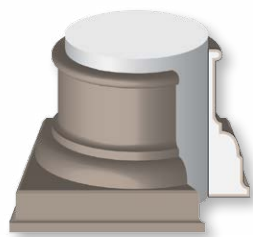

ST 1

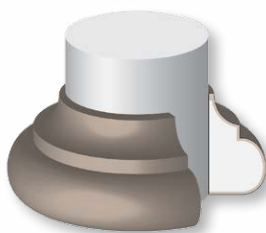

ST 2

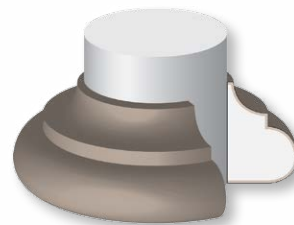

ST 3

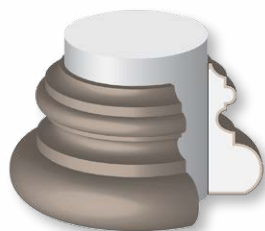

ST 4

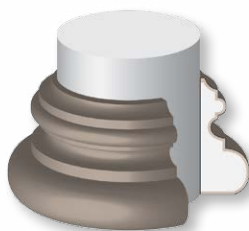

ST 5

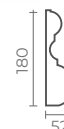
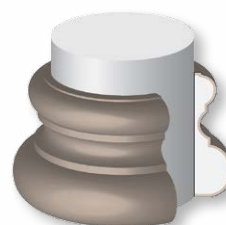

ST 6

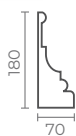
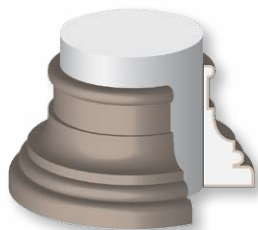

ST 7

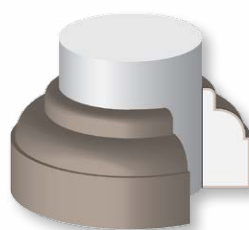

ST 8



ST 9

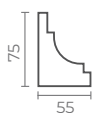
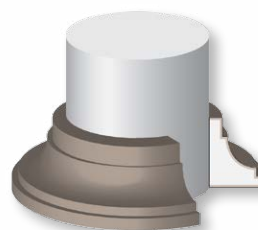

ST 10

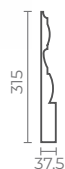

ST 11

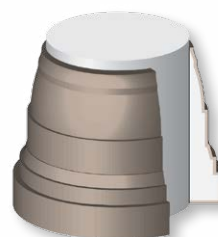

ST 12

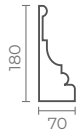
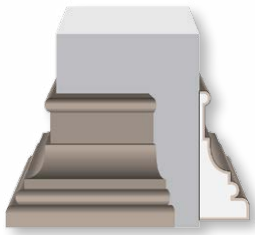

ST 18

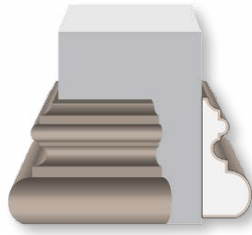

ST 19

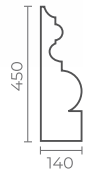
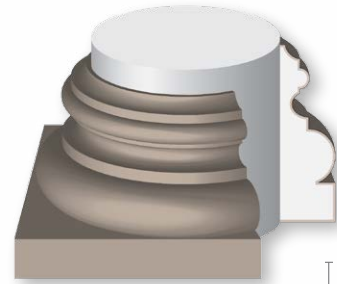

ST 20

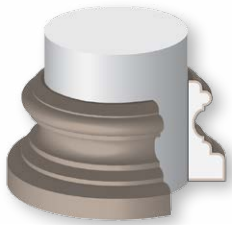

ST 21

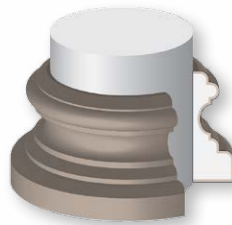

ST 22

FASADNI PILASTERI



UK 21/SP 4/PP 5

KAPITEL - UK 21

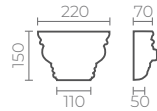

PILASTER - SP 4



BAZA - PP 5

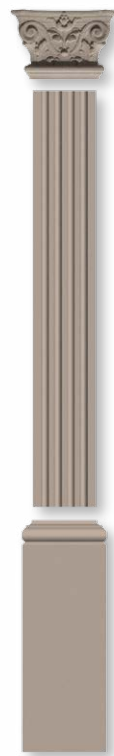
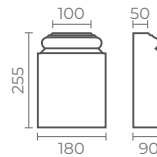

UK 11/OP 419/PP 4

KAPITEL - UK 11

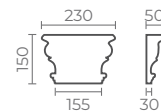

PILASTER - OP 419



BAZA - PP 4

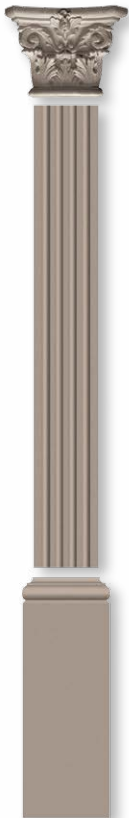
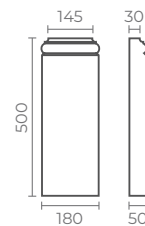

UK 46/OP 419/PP 4

KAPITEL - UK 46

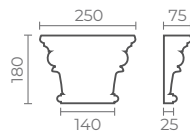

PILASTER - OP 419



BAZA - PP 4

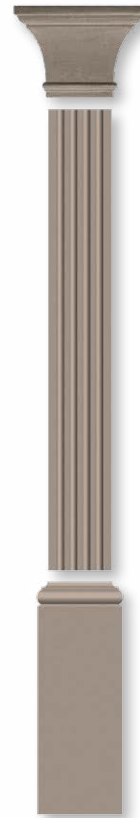
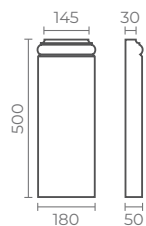

UK 4/OP 419/PP 4

KAPITEL - UK 4

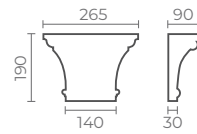

PILASTER - OP 419



BAZA - PP 4

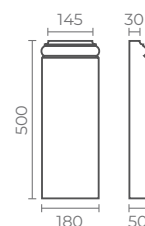

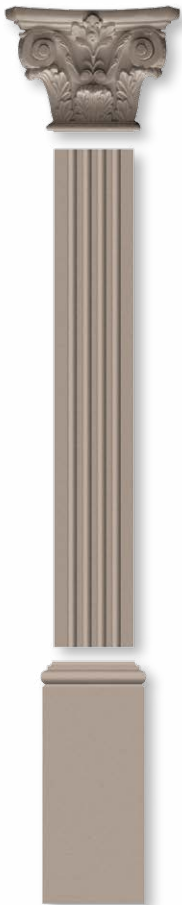

UK 45/OP 423/PP 6

KAPITEL - UK 45

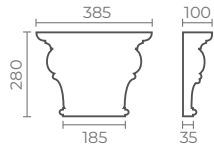

PILASTER - OP 423



BAZA - PP 6

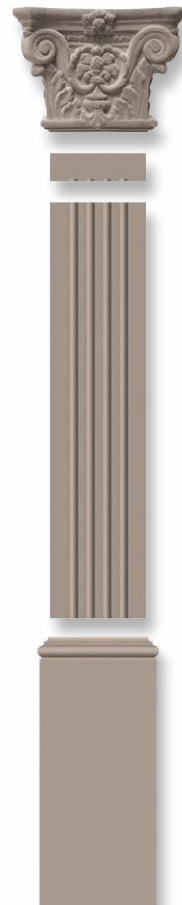
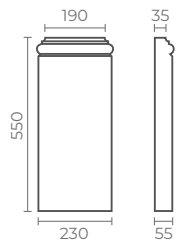

KP 15/P 1/OP 425/PP 1

KAPITEL - KP 15

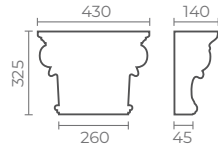

ZAVRŠETAK - P 1

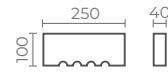

PILASTER - OP 425



BAZA - PP 1

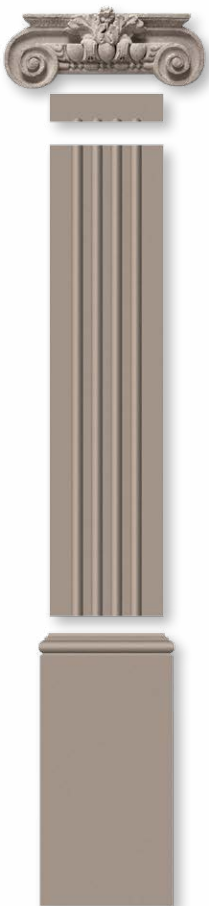
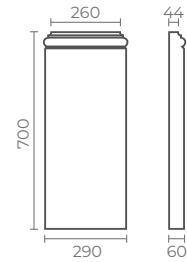

KP 16/P 2/OP 429/PP 2

KAPITEL - KP 16

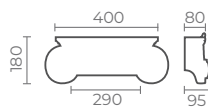

ZAVRŠETAK - P 2

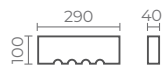

PILASTER - OP 429



BAZA - PP 2

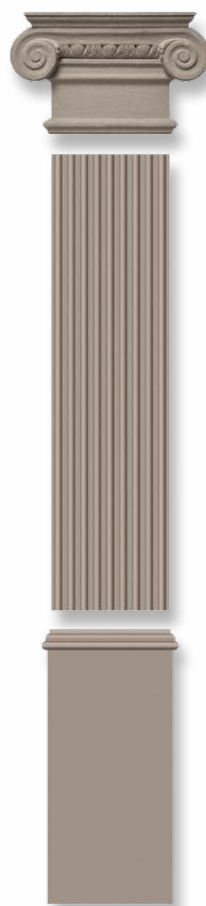
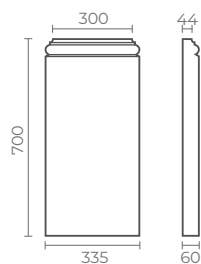

KP 17/OP 426/PP 3

KAPITEL - KP 17

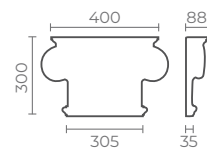

PILASTER - OP 426



BAZA - PP 3

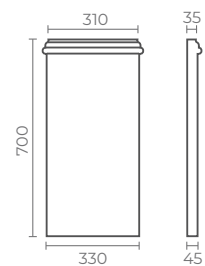

PRIMERI PROZORA

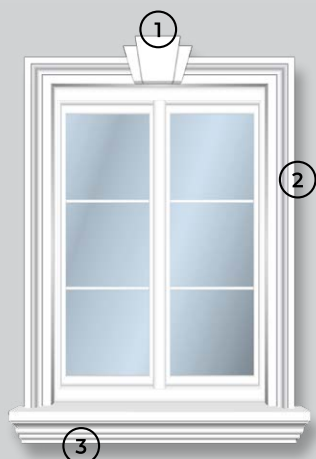

MODEL 1

1. UK 8 3. PP 501 A
2. OP 301 A



MODEL 2

1. PP 574 3. PP 548
2. OP 305

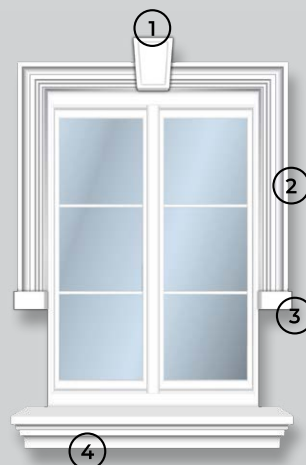

MODEL 3

1. UK 2 3. UK 5
2. OP 323 4. PP 548



MODEL 4

1. OP 304

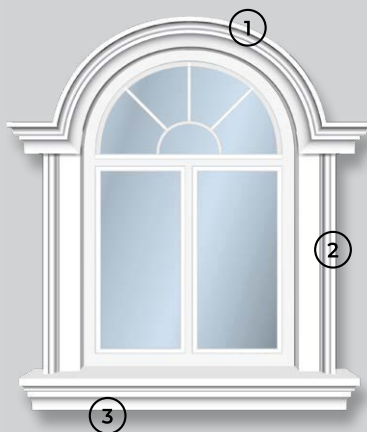

MODEL 5

1. PP 574 3. PP 548
2. OP 304

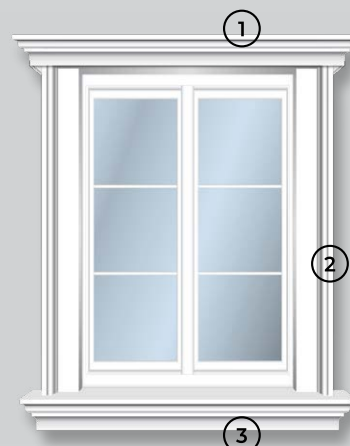

MODEL 6

1. PP 574 3. PP 554
2. OP 304



MODEL 7

1. PP 501 B 3. OP 419
2. UK 11 4. PP 501 A

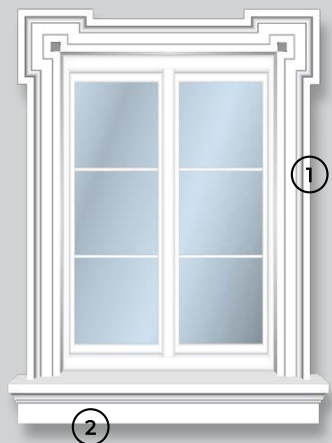

MODEL 8

1. OP 303 A
2. PP 508 B

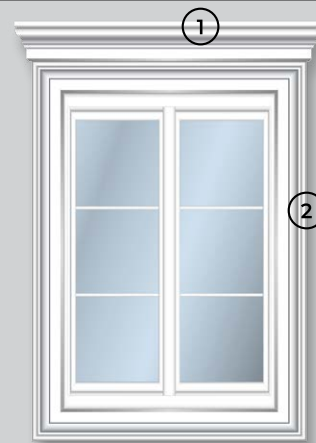

MODEL 9

1. PP 506 B
2. OP 305

* Dimenzije prozora u modelima 1-6 i 8-12 su 120x80 cm

* Dimenzije prozora u modelu 7 su 120x120 cm



MODEL 10

- 1. OP 306 A
- 2. PKL 300



MODEL 11

- 1. OP 301 A
- 2. PP 515 B
- 3. UK VESNA

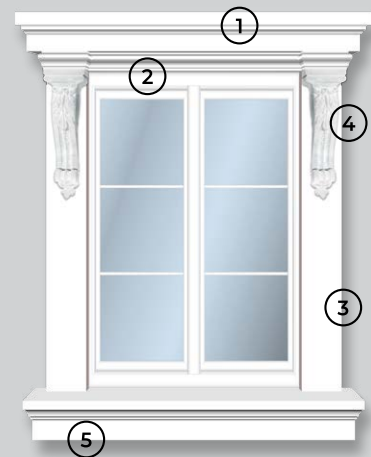

MODEL 12

- 1. PP 515 C
- 2. OP 308
- 3. RS 150
- 4. UK 38
- 5. PP 508 B

PRIMERI SAVIJANJA LUKA



PRIMER 1

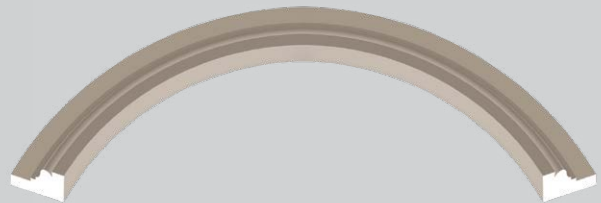

PRIMER 2



PRIMER 3

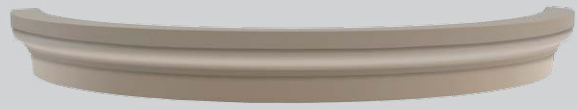

PRIMER 4





Saint Matthew Place
Montenegro





DEKORATIVNI ELEMENTI ZA ENTERIJER

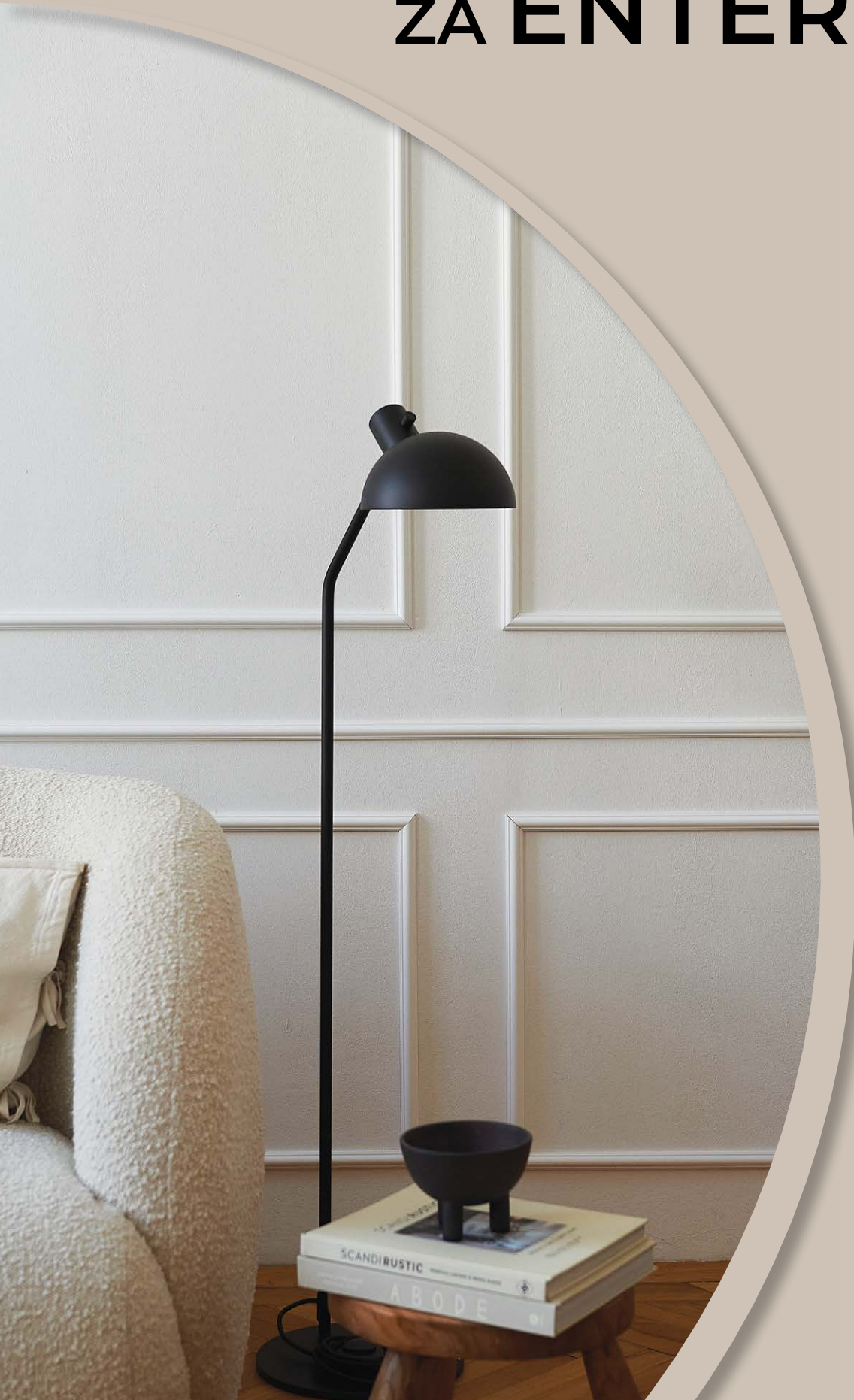

PLAFONSKE LAJSNE

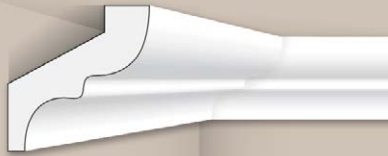

LX 35

L 2000 mm

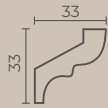

LX 22

L 2000 mm

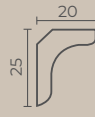

PURE 1

L 2000 mm

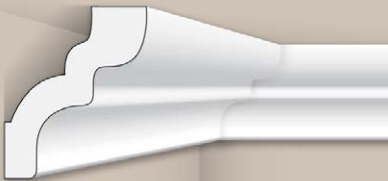
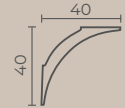

LX 52

L 2000 mm

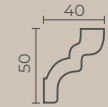

LX 45

L 2000 mm

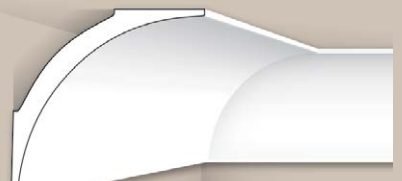

PURE 2

L 2000 mm

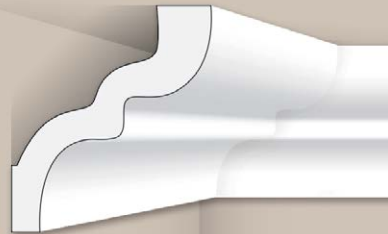
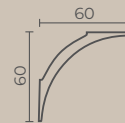

LX 105

L 2000 mm

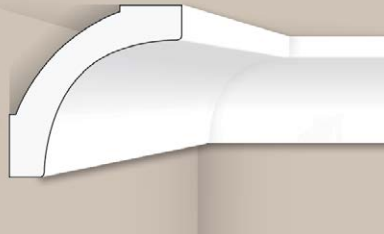
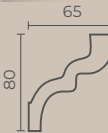

LX 65

L 2000 mm

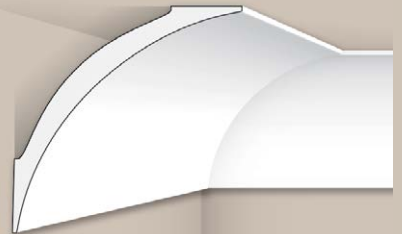
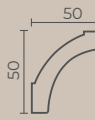

PURE 3

L 2000 mm

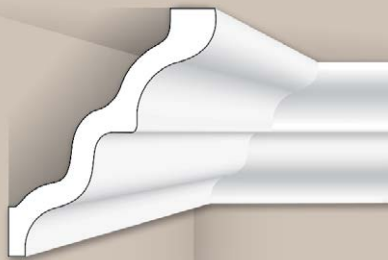
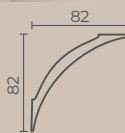

LX 141

L 2000 mm

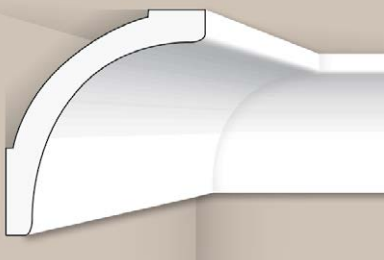

LX 75

L 2000 mm

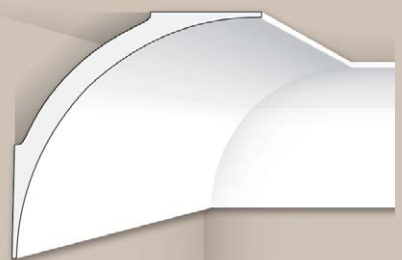

PURE 4

L 2000 mm

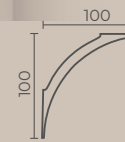



LX 20

L 2000 mm



C 30

L 2000 mm



LX 32

L 2000 mm

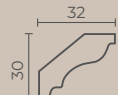

LX 25

L 2000 mm

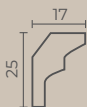

LX 30

L 2000 mm

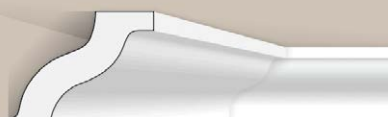
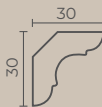

LX 60

L 2000 mm

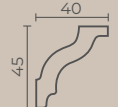

A 3

L 2000 mm



LX 28

L 2000 mm

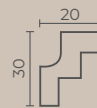

LX 72

L 2000 mm

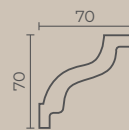

T 70

L 2000 mm

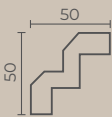

LX 47

L 2000 mm

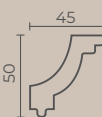

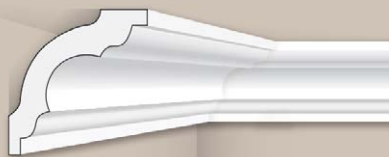

LX 40

L 2000 mm

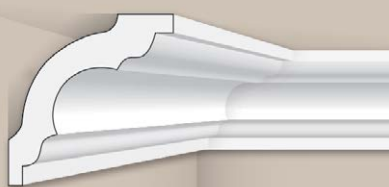
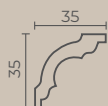

LX 50

L 2000 mm

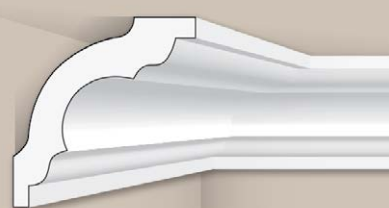
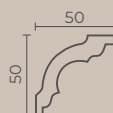

K 60

L 2000 mm

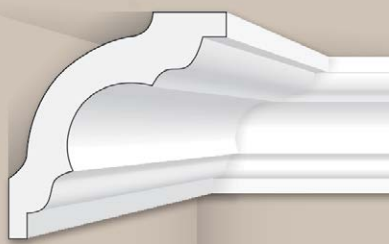
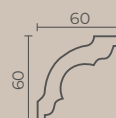

LX 110

L 2000 mm

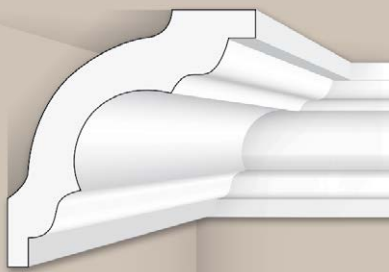
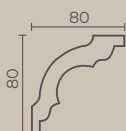

LX 150

L 2000 mm

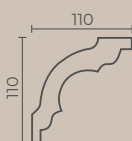

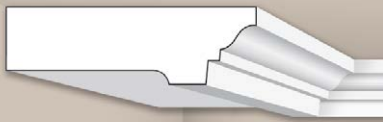

PLA 47

L 2000 mm

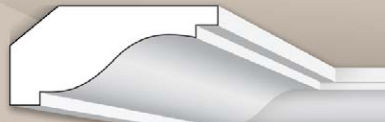
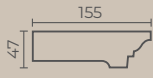

PLA 64

L 2000 mm

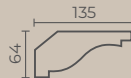

PLA 76

L 2000 mm

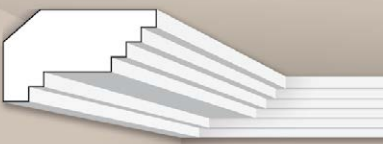
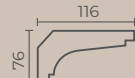

PLA 60

L 2000 mm



PLA 59

L 2000 mm



PLA 123

L 2000 mm



PLA 80

L 2000 mm



PLA 100

L 2000 mm



PLA 120

L 2000 mm



GL 62

L 2000 mm



GL 104

L 2000 mm



GL 105

L 2000 mm





PLA 165

L 2000 mm

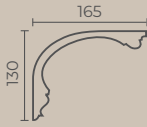

PLA 150

L 2000 mm

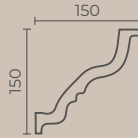

PLA 180

L 2000 mm

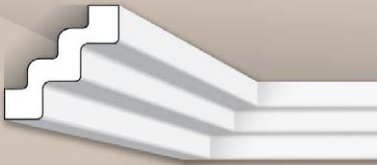
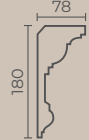

PLA 75

L 2000 mm

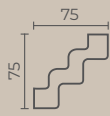

PLA 130

L 2000 mm

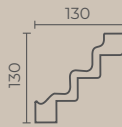

NLA

L 2000 mm



SK 18

L 2000 mm



SK 19

L 2000 mm



SK 20

L 2000 mm

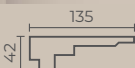

SK 21

L 2000 mm

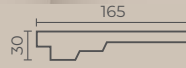







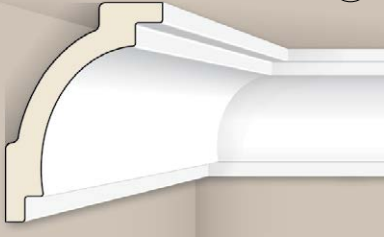
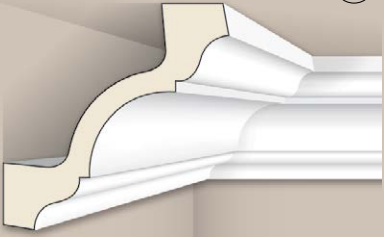
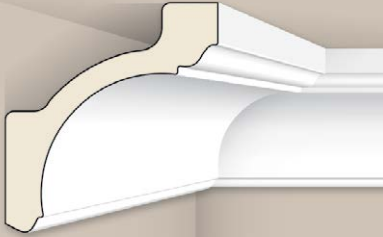

SK 22

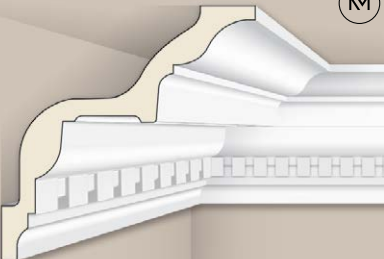
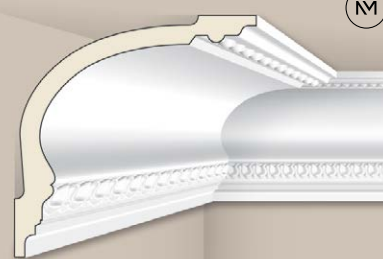
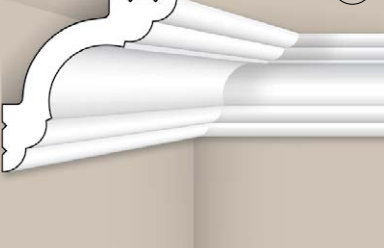
L 2000 mm

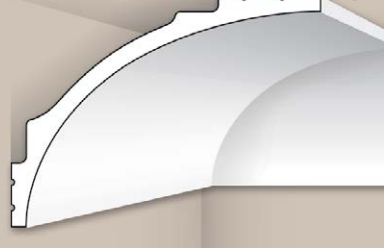

PLAFONSKE LAJSNE **PROFESSIONAL**

 <p>Z 16 L 2000 mm</p> <p>50 70</p> <p>PROFESSIONAL</p> <p>PU LED</p>	 <p>Z 19 L 2000 mm</p> <p>79 79</p> <p>PROFESSIONAL</p> <p>PU</p>	 <p>Z 20 L 2000 mm</p> <p>87 87</p> <p>PROFESSIONAL</p> <p>PU LED</p>
 <p>Z 24 L 2000 mm</p> <p>128 128</p> <p>PROFESSIONAL</p> <p>PU</p>	 <p>Z 5 L 2000 mm</p> <p>128 128</p> <p>PROFESSIONAL</p> <p>PU</p>	 <p>Z 6 L 2000 mm</p> <p>124 124</p> <p>PROFESSIONAL</p> <p>PU</p>
 <p>WT 5 L 2000 mm</p> <p>52 52</p> <p>PROFESSIONAL</p> <p>HD PS</p>	 <p>WT 10 L 2000 mm</p> <p>84 84</p> <p>PROFESSIONAL</p> <p>HD PS</p>	 <p>WT 11 L 2000 mm</p> <p>126 106</p> <p>PROFESSIONAL</p> <p>HD PS</p>
 <p>WT 25 L 2000 mm</p> <p>78 78</p> <p>PROFESSIONAL</p> <p>HD PS</p>	 <p>IL 18 L 2000 mm</p> <p>121 90</p> <p>PROFESSIONAL</p> <p>HD PS</p>	 <p>MD 137 L 2000 mm</p> <p>55 96</p> <p>PROFESSIONAL</p> <p>PolyForce®</p>

PU POLIURETAN

HD PS POLISTIREN VISOKE GUSTINE

OTPORNOST NA VLAGU

PolyForce® POLYFORCE®

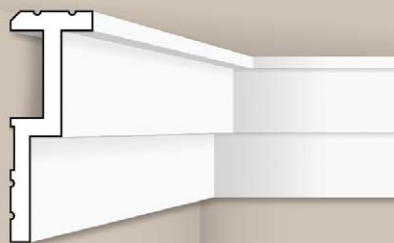

PROFESSIONAL

QL 024

L 2000 mm



PolyForce®

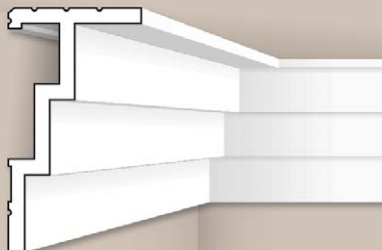

PROFESSIONAL

QL 025

L 2000 mm



PolyForce®



FARBANJE BOJOM NA BAZI VODE



JEDNOSTAVNA MONTAŽA



MOGUĆNOST POSTAVLJANJA LED RASVETE



OTPORNOST NA MEHANIČKA OŠTEĆENJA

PLAFONSKE LAJSNE **PROFESSIONAL**



MDA 067

L 2000 mm

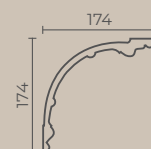

Z 40

L 2000 mm

* KOMBINUJE SE SA
DEKORATIVNIM UGLOM Z42
ILI UKRASNOM LAJSNOM Z41

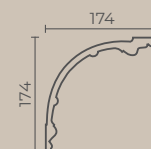

Z 41

L 2000 mm

* KOMBINUJE SE SA
DEKORATIVNIM UGLOM Z42
ILI UKRASNOM LAJSNOM Z40

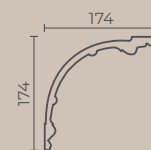
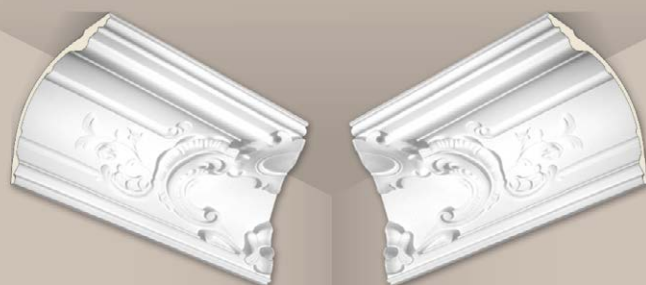

Z 42

L 2000 mm

* KOMBINUJE SE
SA UKRASNIM LAJSNAMA
Z40 I Z41





GRAVIRANE LAJSNE



VD 8

L 2000 mm

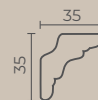

LAURA

L 2000 mm

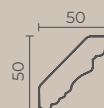

PAMELLA

L 2000 mm

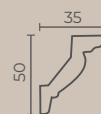

INES

L 2000 mm

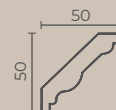



HELENA

L 2000 mm

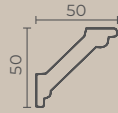

VD 18

L 2000 mm

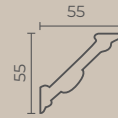

ANNA

L 2000 mm



LISA

L 2000 mm

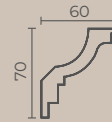

VD 15

L 2000 mm



VERA

L 2000 mm

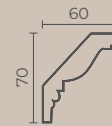

HELLA

L 2000 mm



KAĆA

L 2000 mm

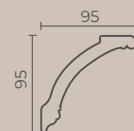



TINA
L 2000 mm

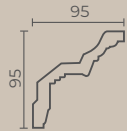

SELINA
L 2000 mm



VIKTORIA
L 2000 mm

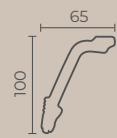

MARIJA
L 2000 mm

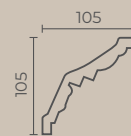

ANDREA
L 2000 mm

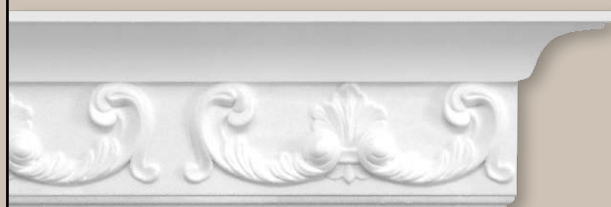
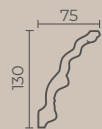

ISABELL
L 2000 mm

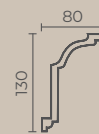

PROFESSIONAL
MDA 067
L 2000 mm



SKRIVAČI RASVETE

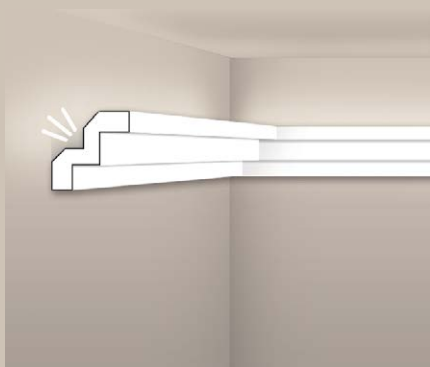

T 70

L 2000 mm

PREPORUKA: ZALEPITI ALU REFLEKTUJUČU TRAKU



SK 14

L 2000 mm

PREPORUKA: ZALEPITI ALU REFLEKTUJUČU TRAKU



SK 13

L 2000 mm

PREPORUKA: ZALEPITI ALU REFLEKTUJUČU TRAKU

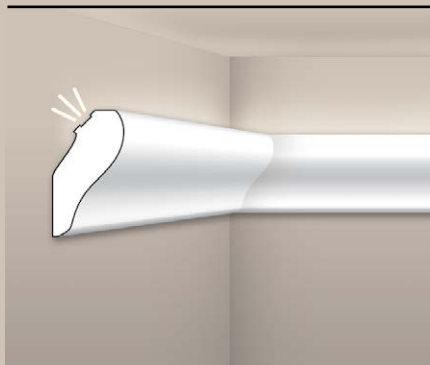

SK 10

L 2000 mm

PREPORUKA: ZALEPITI ALU REFLEKTUJUČU TRAKU

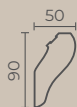

SK 11

L 2000 mm

PREPORUKA: POLEĐINU SKRIVAČA OFARBATI U CRNU BOJU

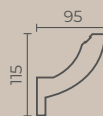

SK 12

L 2000 mm

PREPORUKA: MONTIRATI NADGRADNI ALU PROFIL ZA LED TRAKU

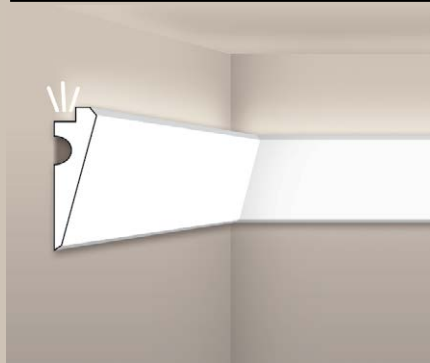

SK 17

L 2000 mm

PREPORUKA: ZALEPITI ALU REFLEKTUJUČU TRAKU



SK 15

L 2000 mm

PREPORUKA: ZALEPITI ALU REFLEKTUJUČU TRAKU



SK 16

L 2000 mm

PREPORUKA: ZALEPITI ALU REFLEKTUJUČU TRAKU



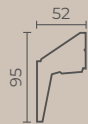
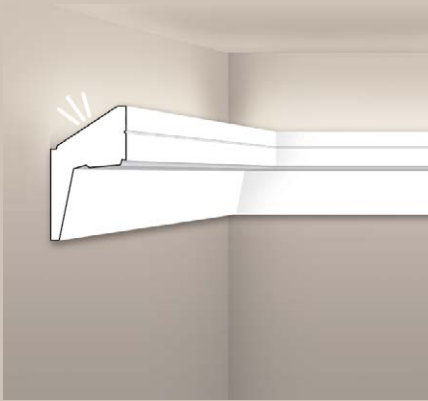

SK 23

L 2000 mm

PREPORUKA: ZALEPITI ALU REFLEKTUJUĆU TRAKU

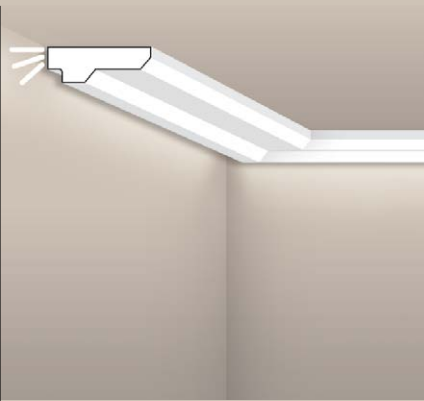

SK 18

L 2000 mm

PREPORUKA: POLEĐINU SKRIVAČA OFARBATI U CRNU BOJU

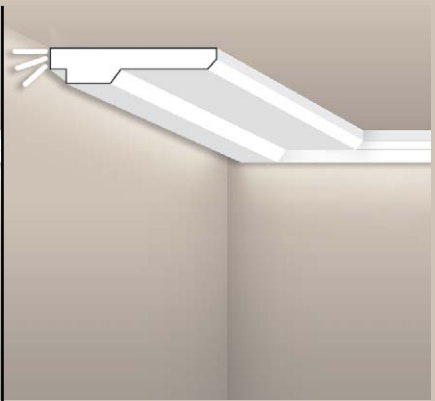

SK 19

L 2000 mm

PREPORUKA: POLEĐINU SKRIVAČA OFARBATI U CRNU BOJU

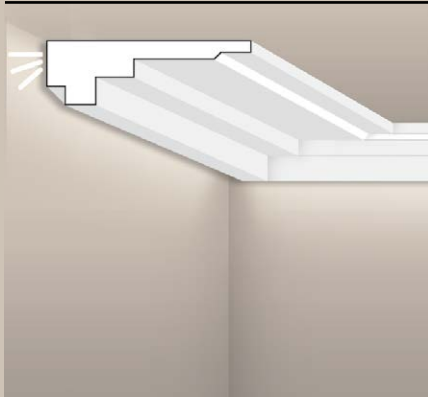

SK 20

L 2000 mm

PREPORUKA: POLEĐINU SKRIVAČA OFARBATI U CRNU BOJU

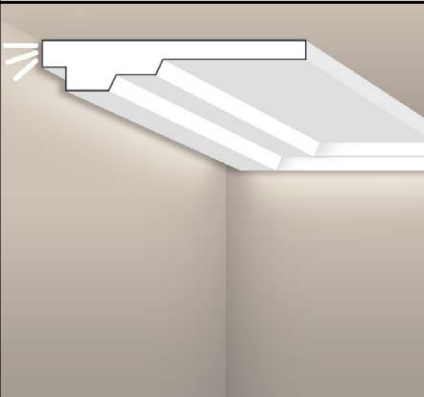

SK 21

L 2000 mm

PREPORUKA: POLEĐINU SKRIVAČA OFARBATI U CRNU BOJU

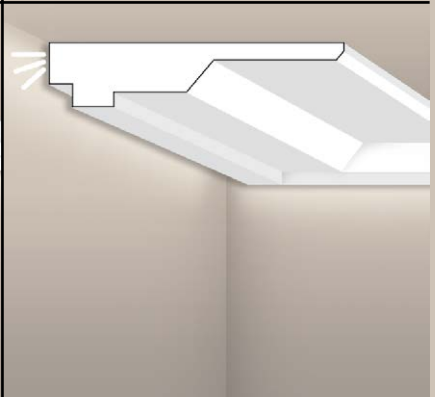

SK 22

L 2000 mm

PREPORUKA: POLEĐINU SKRIVAČA OFARBATI U CRNU BOJU

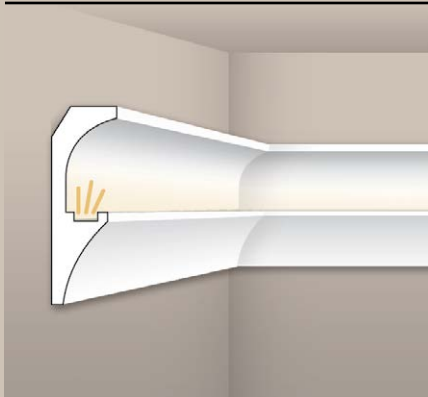

SK-S1

L 2000 mm

PREPORUKA: MONTIRATI UGRADNI ALU PROFIL ZA LED TRAKU

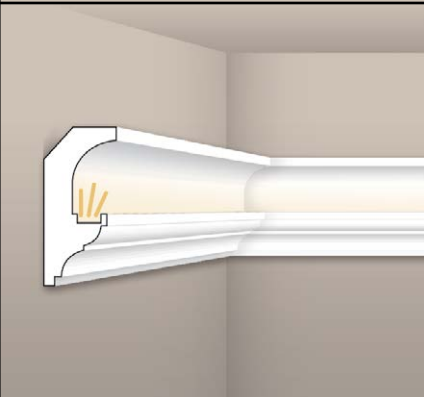

SK-S2

L 2000 mm

PREPORUKA: MONTIRATI UGRADNI ALU PROFIL ZA LED TRAKU

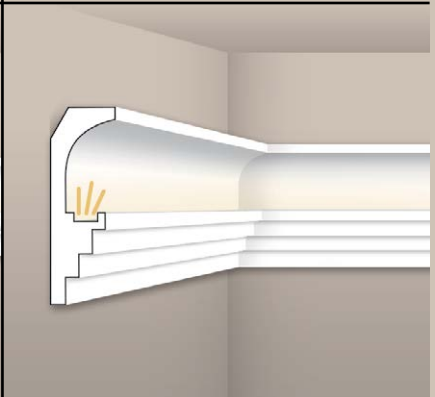

SK-S3

L 2000 mm

PREPORUKA: MONTIRATI UGRADNI ALU PROFIL ZA LED TRAKU





ALU REFLEKTUJUĆA TRAKA

Š 50 mm

L 10 000 mm

PREPORUKE

U CILJU SPREČAVANJA
PRODIRANJA SVETLA KROZ
SKRIVAČ RASVETE,
PREPORUČUJE SE UPOTREBA
DODATNIH ELEMENATA:

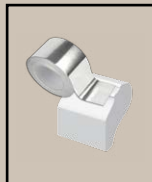

LEPLJENJE
ALU-REFLEKTUJUĆE
TRAKE

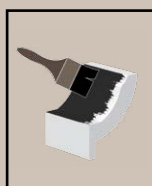

FARBANJE
POLEDINE SKRIVAČA
RASVETE U CRNU
BOJU

* ne vršimo uslugu farbanja
poledine skrivača rasvete



MONTAŽA
NADGRADNOG
ALU-PROFILA
ZA LED TRAKU

* nadgradni profil se ne
nalazi u našoj ponudi
proizvoda



MONTAŽA
UGRADNOG
ALU-PROFILA
ZA LED TRAKU

* ugradni profil se ne nalazi
u našoj ponudi proizvoda



SKRIVAČI RASVETE **PROFESSIONAL**

 <p>(M)</p>	 <p>(M)</p>	 <p>(M)</p>
<p>PROFESSIONAL</p> <p>W 1 L 2000 mm PREPORUKA: ZALEPITI ALU REFLEKTUJUĆU TRAKU</p>  <p>HD PS LED</p>	<p>PROFESSIONAL</p> <p>IL 3 L 2000 mm</p>  <p>HD PS LED</p>	<p>PROFESSIONAL</p> <p>IL 13 L 2000 mm</p>  <p>HD PS LED</p>
 <p>(M)</p>	 <p>(M)</p>	 <p>(M)</p>
<p>PROFESSIONAL</p> <p>IL 4 L 2000 mm</p>  <p>HD PS LED</p>	<p>PROFESSIONAL</p> <p>IL 5 L 2000 mm</p>  <p>PU LED</p>	<p>PROFESSIONAL</p> <p>IL 1 L 2000 mm</p>  <p>PU LED</p>
 <p>(M)</p>	 <p>(M)</p>	 <p>(M)</p>
<p>PROFESSIONAL</p> <p>Z 16 L 2000 mm</p>  <p>PU LED</p>	<p>PROFESSIONAL</p> <p>Z 20 L 2000 mm</p>  <p>PU LED</p>	<p>PROFESSIONAL</p> <p>IL 2 L 2000 mm</p>  <p>PU LED</p>

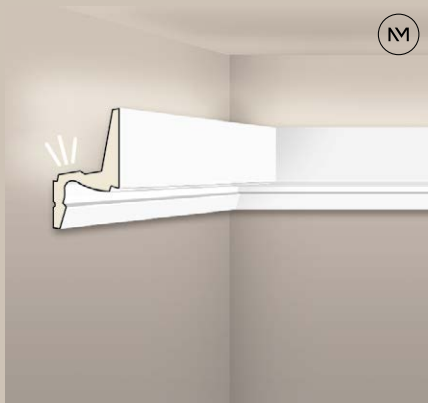

(M)

PROFESSIONAL

IL 7

L 2000 mm

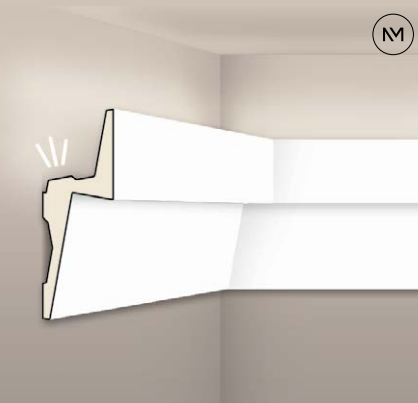

(M)

PROFESSIONAL

IL 8

L 2000 mm

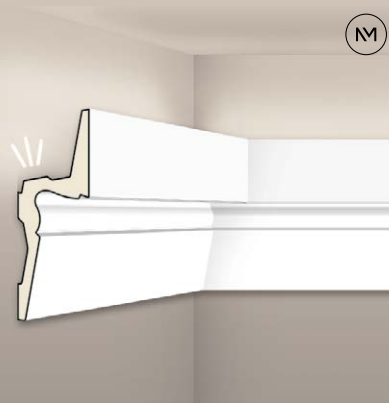

(M)

PROFESSIONAL

IL 9

L 2000 mm

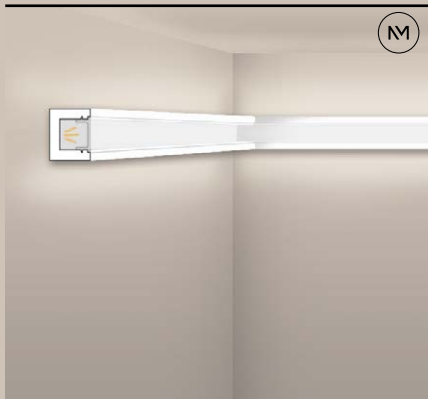

(M)

PROFESSIONAL

IL 12

L 2000 mm

NAPOMENA: UZ LAJSNU JE UKLJUČEN I DIFUZOR SVETLA

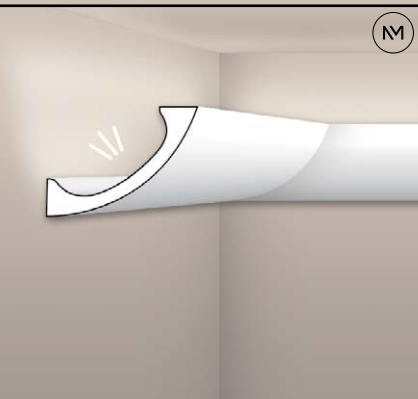

(M)

PROFESSIONAL

WT 3

L 2000 mm

PREPORUKA: ZALEPITI ALU REFLEKTUJUĆU TRAKU

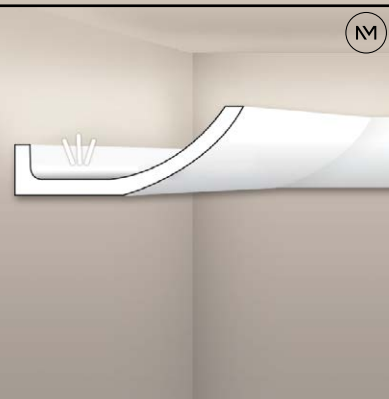
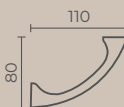

(M)

PROFESSIONAL

WT 4

L 2000 mm

PREPORUKA: ZALEPITI ALU REFLEKTUJUĆU TRAKU

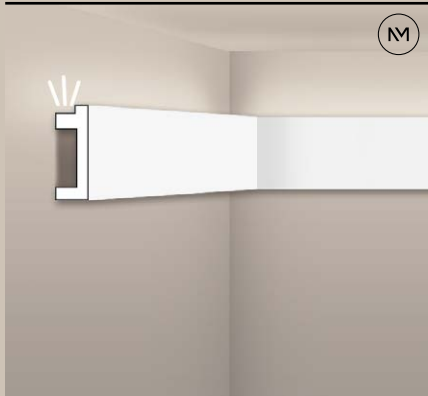
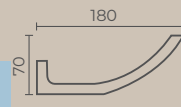

(M)

PROFESSIONAL

CU-LED

L 2000 mm

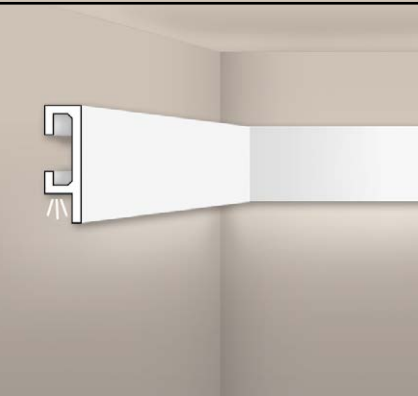

(M)

PROFESSIONAL

QL 019

L 2000 mm

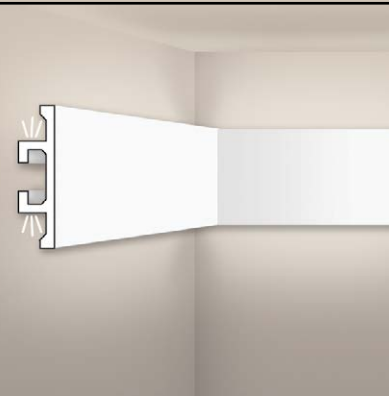

(M)

PROFESSIONAL

QL 017

L 2000 mm



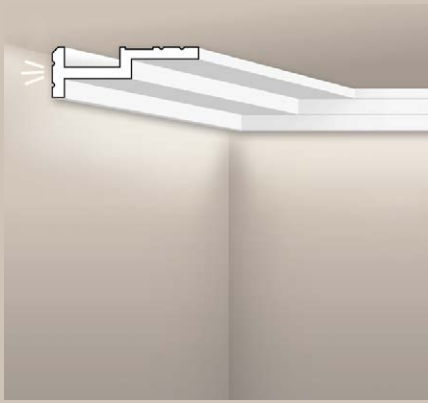

QL 024

L 2000 mm

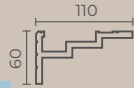
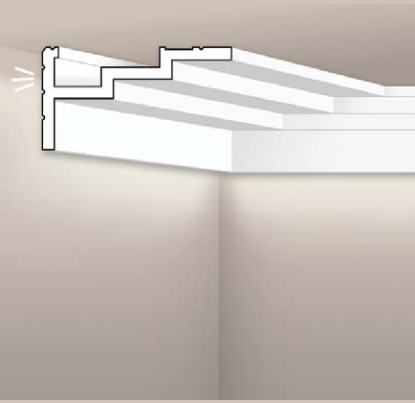

QL 025

L 2000 mm

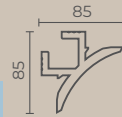
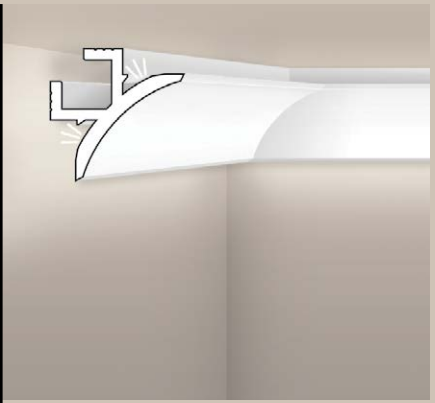

QL 002

L 2000 mm

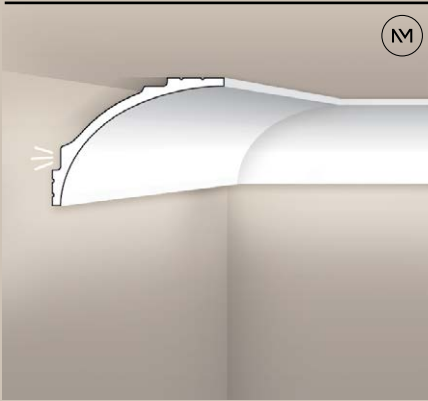

(M)

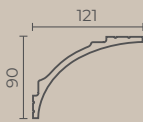

PROFESSIONAL

IL 18

L 2000 mm



PODNI SKRIVAČI RASVETE

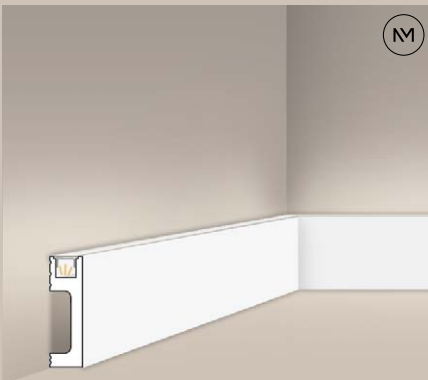

(M)



PROFESSIONAL

IL 10

L 2000 mm

NAPOMENA: UZ LAJSNU
JE UKLJUČEN I DIFUZOR SVETLA

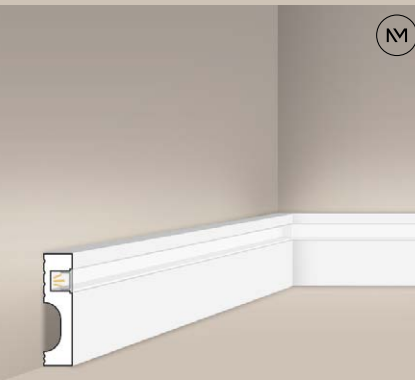

(M)



PROFESSIONAL

IL 11

L 2000 mm

NAPOMENA: UZ LAJSNU
JE UKLJUČEN I DIFUZOR SVETLA





FARBANJE BOJOM NA BAZI VODE



OTPORNOST NA MEHANIČKA OŠTEČENJA



LED MOGUČNOST POSTAVLJANJA LED RASVETE



JEDNOSTAVNA MONTAŽA

SKRIVAČI KARNIŠE

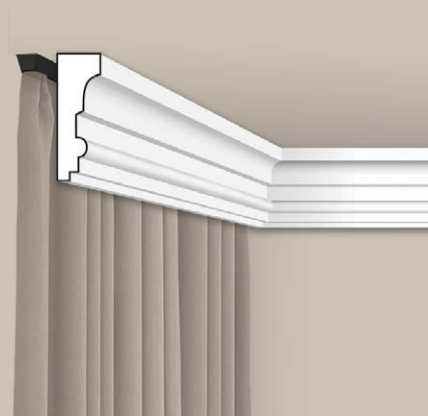

GL 62

L 2000 mm

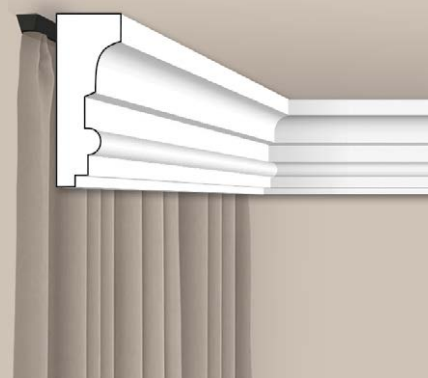

GL 104

L 2000 mm





GL 105

L 2000 mm

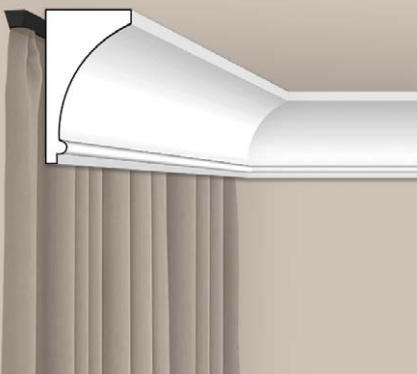

PLA 80

L 2000 mm

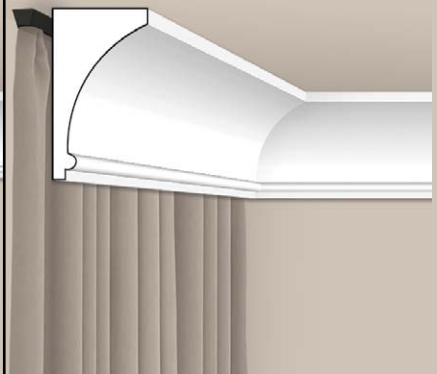

PLA 100

L 2000 mm

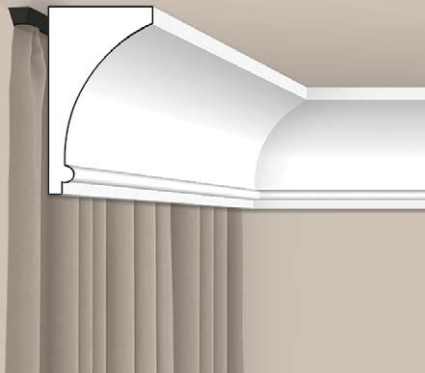

PLA 120

L 2000 mm

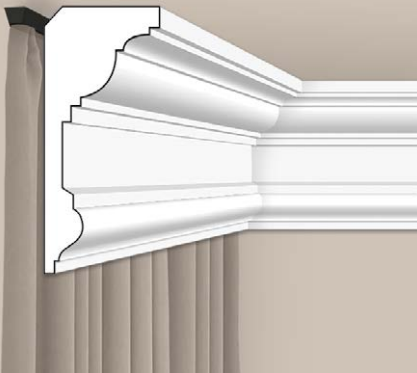
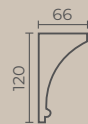

PLA 180

L 2000 mm

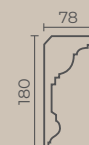

PROFESSIONAL

MD 137

L 2000 mm

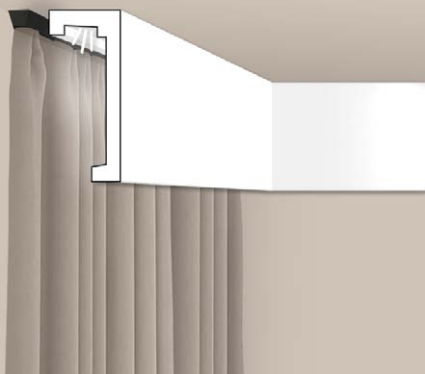

PROFESSIONAL

QL 026 T

L 2000 mm

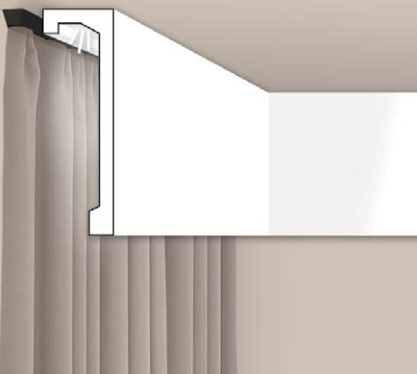

PROFESSIONAL

QL 036 T

L 2000 mm





ZIDNE LAJSNE



I 20

L 2000 mm



U 40

L 2000 mm

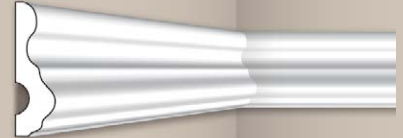

I 60

L 2000 mm



LX 70

L 2000 mm



LX 41

L 2000 mm

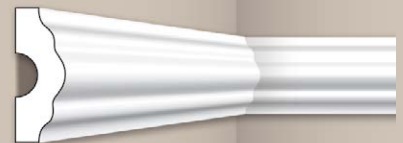

I 40

L 2000 mm



FL 50

L 2000 mm



LX 42

L 2000 mm

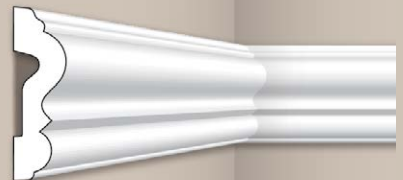

PLA 82

L 2000 mm



ZIDNE LAJSNE **PROFESSIONAL**

 <p>PROFESSIONAL SP 1 L 2000 mm</p>  <p>28 9</p> <p>PU</p> 	 <p>PROFESSIONAL SP 2 L 2000 mm</p>  <p>22 9</p> <p>PU</p> 	 <p>PROFESSIONAL SP 3 L 2000 mm</p>  <p>23 13 13</p> <p>PU</p> 
 <p>PROFESSIONAL CW 10 L 2000 mm</p>  <p>25 10</p> <p>HD PS</p> 	 <p>PROFESSIONAL CW 11 L 2000 mm</p>  <p>38 18</p> <p>HD PS</p> 	 <p>PROFESSIONAL WL 1 L 2000 mm</p>  <p>38 18</p> <p>HD PS</p> 
 <p>PROFESSIONAL WL 14 L 2000 mm</p>  <p>14.5 20</p> <p>HD PS</p> 	 <p>PROFESSIONAL FL 15 L 2000 mm</p>  <p>18 10</p> <p>HD PS</p> 	 <p>PROFESSIONAL WL 7 L 2000 mm</p>  <p>25 13 13</p> <p>HD PS</p> 
 <p>PROFESSIONAL WL 12 L 2000 mm</p>  <p>25 11</p> <p>HD PS</p> 	 <p>PROFESSIONAL WL 13 L 2000 mm</p>  <p>24 14.5 14.5</p> <p>HD PS</p> 	 <p>PROFESSIONAL WL 3 L 2000 mm</p>  <p>38 16 16</p> <p>HD PS</p> 

 <p>PROFESSIONAL WL 2 L 2000 mm</p>  	 <p>PROFESSIONAL WL 11 L 2000 mm</p>  	 <p>PROFESSIONAL T 40 L 2000 mm</p>  
 <p>PROFESSIONAL WL 10 L 2000 mm</p>  	 <p>PROFESSIONAL MD 012 L 2000 mm</p>  	 <p>PROFESSIONAL W 1 L 2000 mm</p>  
 <p>PROFESSIONAL WD 5 L 2000 mm</p>  	 <p>PROFESSIONAL WD 4 L 2000 mm</p>  	 <p>PROFESSIONAL WD 2 L 2000 mm</p>  
 <p>PROFESSIONAL CW 12 L 2000 mm</p>  	 <p>PROFESSIONAL FD 7 L 2000 mm</p>  	 <p>PROFESSIONAL WL 5 L 2000 mm</p>  



 <p>Z 10 L 2000 mm</p>  <p>PROFESSIONAL</p> <p>PU</p> 	 <p>Z 1550 L 2000 mm</p>  <p>PROFESSIONAL</p> <p>PU</p> 	 <p>Z 1360 L 2000 mm</p>  <p>PROFESSIONAL</p> <p>PU</p> 
 <p>Z 13 L 2000 mm</p>  <p>PROFESSIONAL</p> <p>PU</p> 	 <p>Z 30 L 2000 mm</p>  <p>PROFESSIONAL</p> <p>PU</p> 	 <p>Z 32 L 2000 mm</p>  <p>PROFESSIONAL</p> <p>PU</p> 
 <p>Z 31 L 2000 mm</p>  <p>PROFESSIONAL</p> <p>PU</p> 	 <p>WL 4 L 2000 mm</p>  <p>PROFESSIONAL</p> <p>HD PS</p> 	 <p>Z 1 L 2000 mm</p>  <p>PROFESSIONAL</p> <p>PU</p> 
 <p>Z 12 L 2000 mm</p>  <p>PROFESSIONAL</p> <p>PU</p> 	 <p>Z 61 L 2000 mm</p>  <p>PROFESSIONAL</p> <p>PU</p> 	

ZIDNE PANEL LAJSNE **PROFESSIONAL**





PODNE LAJSNE **PROFESSIONAL**

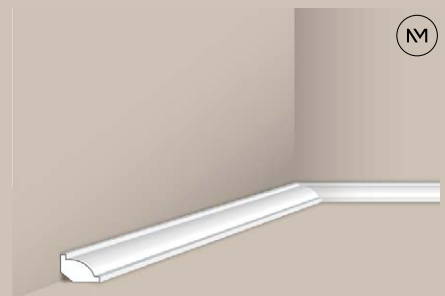

(M)

PROFESSIONAL

WT 7

L 2000 mm

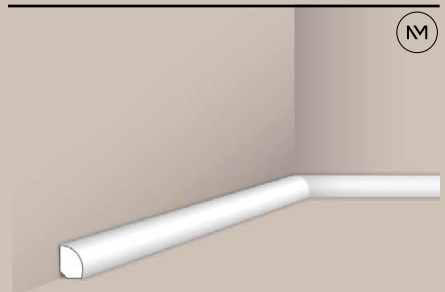

(M)

PROFESSIONAL

FL 6

L 2000 mm

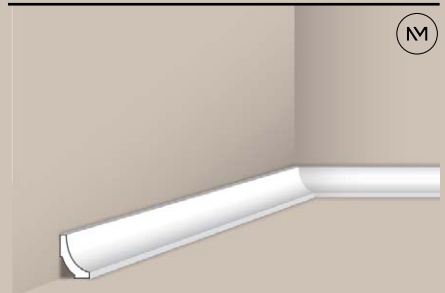

(M)

PROFESSIONAL

WT 8

L 2000 mm



 <p>PROFESSIONAL FL 15 L 2000 mm</p>  	 <p>PROFESSIONAL FT 1 L 2000 mm</p>  	 <p>PROFESSIONAL FT 2 L 2000 mm</p>  
 <p>PROFESSIONAL FL 11 P L 2000 mm</p>  	 <p>PROFESSIONAL WD 4 L 2000 mm</p>  	 <p>PROFESSIONAL FD 1 L 2000 mm</p>  
 <p>PROFESSIONAL FL 3 L 2000 mm</p>  	 <p>PROFESSIONAL FD 3 L 2000 mm</p>  	 <p>PROFESSIONAL FL 5 L 2000 mm</p>  
 <p>PROFESSIONAL FB 1 L 2000 mm</p>  	 <p>PROFESSIONAL FL 2 L 2000 mm</p>  	 <p>PROFESSIONAL FO 1 L 2000 mm</p>  

 <p>PROFESSIONAL CF 11 L 2000 mm</p>  	 <p>PROFESSIONAL FL 1 L 2000 mm</p>  	 <p>PROFESSIONAL CF 12 L 2000 mm</p>  
 <p>PROFESSIONAL FB 2 L 2000 mm</p>  	 <p>PROFESSIONAL FL 14 L 2000 mm</p>  	 <p>PROFESSIONAL FL 17 L 2000 mm</p>  
 <p>PROFESSIONAL FT 8 L 2000 mm</p>  	 <p>PROFESSIONAL FD 7 L 2000 mm</p>  	 <p>PROFESSIONAL FD 11 L 2000 mm</p>  
 <p>PROFESSIONAL FL 4 L 2000 mm</p>  	 <p>PROFESSIONAL FD 21 L 2000 mm</p>  	 <p>PROFESSIONAL CF 13 L 2000 mm</p>  

(M)

PROFESSIONAL
FD 2 S
L 2000 mm

110 15

HDPS

(M)

PROFESSIONAL
FL 9
L 2000 mm

100 10

HDPS

(M)

PROFESSIONAL
FT 18
L 2000 mm

180 20

HDPS

(M)

PROFESSIONAL
FD 2
L 2000 mm

110 15

HDPS

(M)

PROFESSIONAL
FD 15
L 2000 mm

150 16

HDPS

(M)

PROFESSIONAL
FD 20
L 2000 mm

200 16

HDPS

(M)

PROFESSIONAL
FD 22
L 2000 mm

130 16

HDPS

(M)

PROFESSIONAL
CF 14
L 2000 mm

130 16

HDPS

(M)

PROFESSIONAL
CF 1
L 2000 mm

88 110 22

HDPS

(M)

PROFESSIONAL
CF 2
L 2000 mm

98 110 22

HDPS

(M)

PROFESSIONAL
CF 2 S
L 2000 mm

98 110 22

HDPS

(M)

PROFESSIONAL
CF 3
L 2000 mm

83 120 22

HDPS

DEKORATIVNO POSTOLJE



STANDARD

DM 1

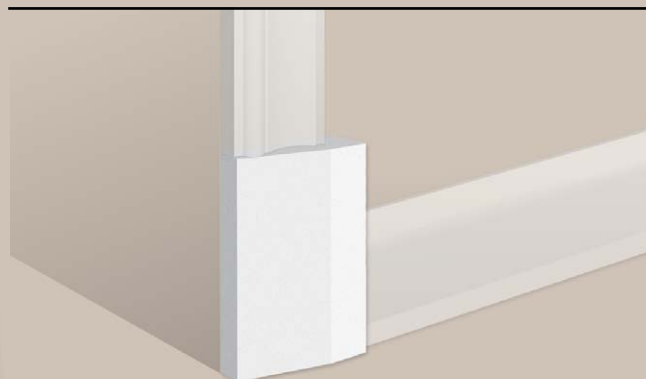
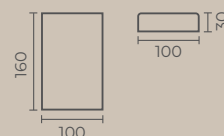

STANDARD

DM 2

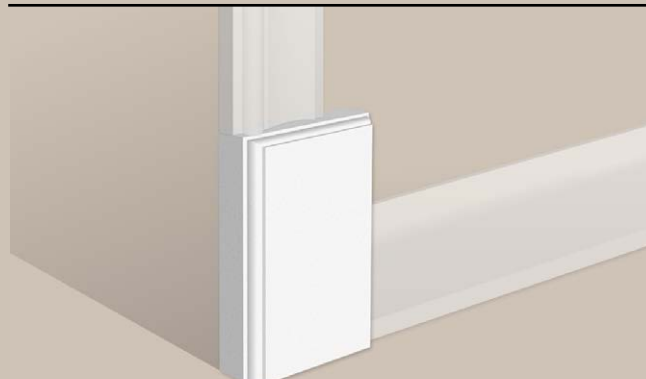
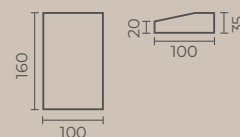

STANDARD

DM 3

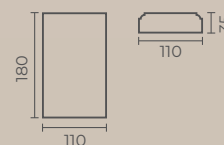

PU POLIURETAN

HDPS POLISTIREN VISOKE GUSTINE

IVIČNE LAJSNE

(M)

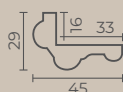

UG 32

L 2000 mm



PROFESSIONAL
CP 20

L 2000 mm

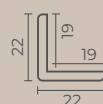

PROFESSIONAL
WE 1

L 2000 mm



(M)

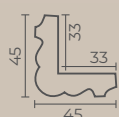
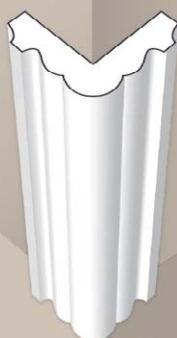

UG 33

L 2000 mm



PROFESSIONAL
CP 30

L 2000 mm



PROFESSIONAL
WE 2

L 2000 mm

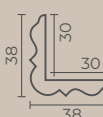

OTPORNOST NA VLAGU



OTPORNOST NA MEHANIČKA OŠTEČENJA



JEDNOSTAVNA MONTAŽA



EKSTRUDIRANI POLISTIREN



FARBANJE BOJOM NA BAZI VODE





FLEKSIBILNE LAJSNE

PROFESSIONAL

SMER SAVIJANJA PROFILA NA PLAFONU,
ZIDU I PODU

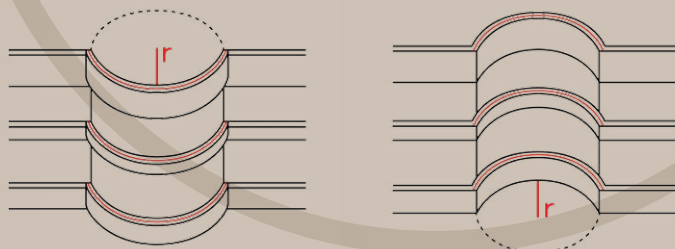

LAJSNA	MIN. RADIJUS
Z 10 FLEX	20 cm
Z 13 FLEX	70 cm
Z 16 FLEX	165 cm
Z 19 FLEX	250 cm
Z 1360 FLEX	20 cm
FL 1 FLEX	20 cm
FL 2 FLEX	20 cm
FD 2 FLEX	20 cm
FD 2 S FLEX	20 cm
WD 2 FLEX	20 cm

SMER SAVIJANJA PROFILA NA ZIDNIM
POVRŠINAMA - OKO VRATA, PROLAZA,
PROZORA I SL.

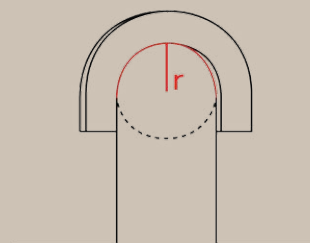

LAJSNA	MIN. RADIJUS
Z 10 FLEX	30 cm
Z 13 FLEX	90 cm
Z 1360 FLEX	60 cm
FL 1 FLEX	110 cm
FL 2 FLEX	140 cm
FD 2 S FLEX	140 cm
WD 2 FLEX	100 cm

PLAFONSKE LAJSNE

(M)



PROFESSIONAL

Z 16 FLEX

L 2000 mm

* Kombinuje se sa plafonskom lajsnom Z 16

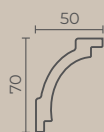

(M)



PROFESSIONAL

Z 19 FLEX

L 2000 mm

* Kombinuje se sa plafonskom lajsnom Z 19

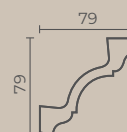

ZIDNE LAJSNE

(M)



PROFESSIONAL

Z 10 FLEX

L 2000 mm

* Kombinuje se sa zidnom lajsnom Z 10



(M)



PROFESSIONAL

Z 1360 FLEX

L 2000 mm

* Kombinuje se sa zidnom lajsnom Z 1360



(M)



PROFESSIONAL

Z 13 FLEX

L 2000 mm

* Kombinuje se sa zidnom lajsnom Z 13



(M)



PROFESSIONAL

WD 2 FLEX

L 2000 mm

* Kombinuje se sa zidnom lajsnom WD 2



PODNE LAJSNE

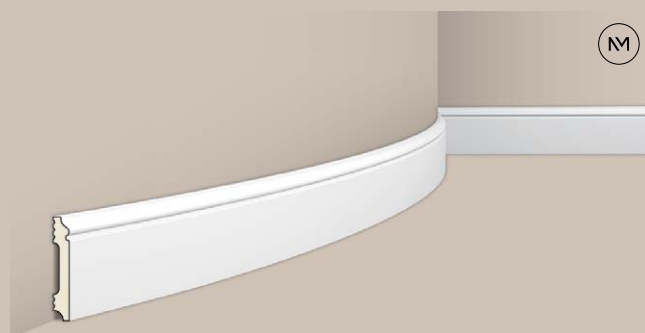

(M)

PROFESSIONAL

FL 1 FLEX

L 2000 mm

* Kombinuje se sa podnom lajsnom **FL 1**



(M)

PROFESSIONAL

FL 2 FLEX

L 2000 mm

* Kombinuje se sa podnom lajsnom **FL 2**

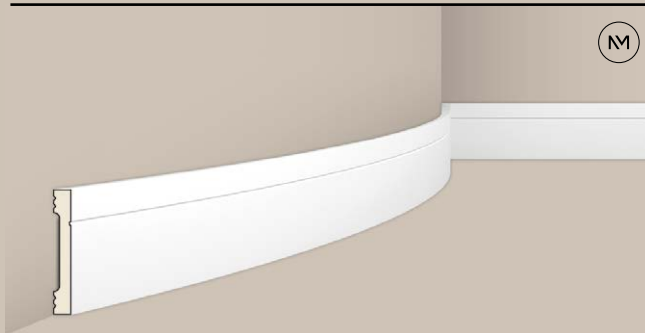

(M)

PROFESSIONAL

FD 2 FLEX

L 2000 mm

* Kombinuje se sa podnom lajsnom **FD 2**

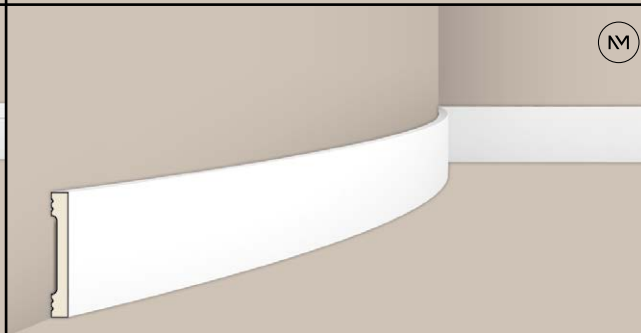

(M)

PROFESSIONAL

FD 2 S FLEX

L 2000 mm

* Kombinuje se sa podnom lajsnom **FD 2 S**



PU POLIURETAN

OTPORNOST NA VLAGU

OTPORNOST NA MEHANIČKA OŠTEĆENJA

JEDNOSTAVNA MONTAŽA



DEKORATIVNI UGLOVI

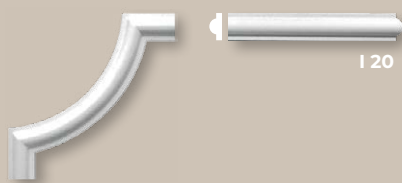

I 20

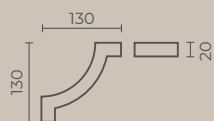

BI 20

*kombinuje se sa zidnom lajsnom I 20

EPS

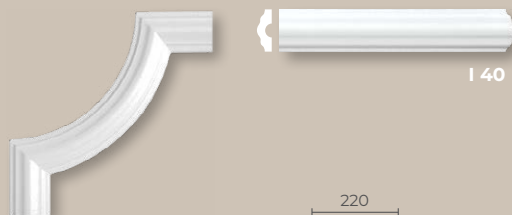

I 40

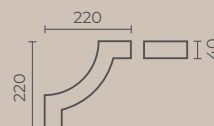

BI 40

*kombinuje se sa zidnom lajsnom I 40

EPS

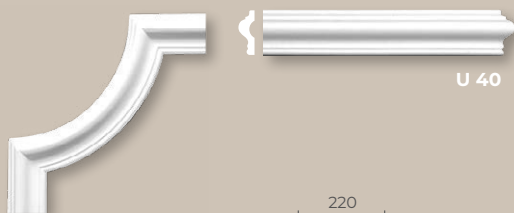

U 40

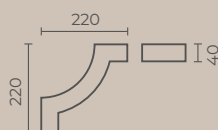

BU 40

*kombinuje se sa zidnom lajsnom U 40

EPS

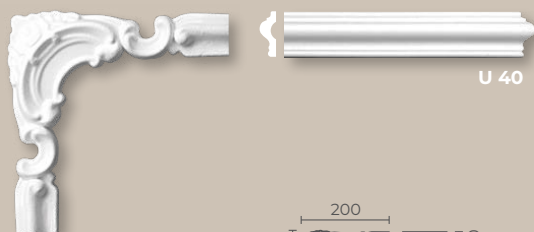

U 40

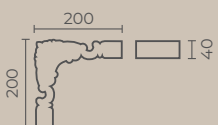

BU 40 D

*kombinuje se sa zidnom lajsnom U 40

EPS

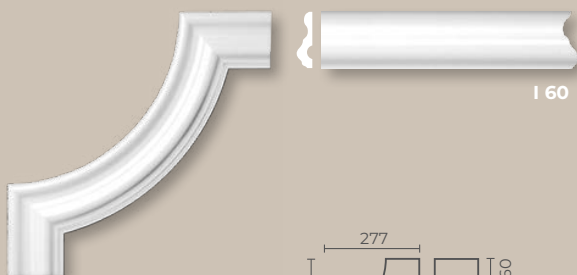

I 60

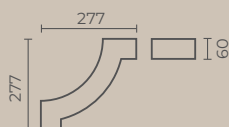

BI 60

*kombinuje se sa zidnom lajsnom I 60

EPS





SP 3

STANDARD

SP 3-4

*kombinuje se sa zidnom lajsnom **SP 3**

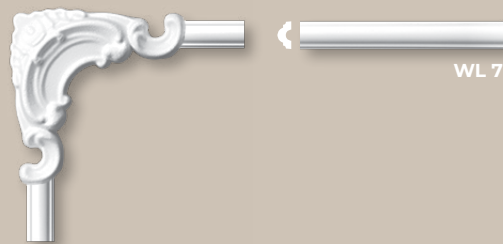
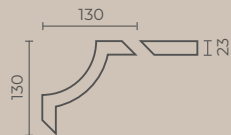

WL 7

STANDARD

WL 701

*kombinuje se sa zidnom lajsnom **WL 7**

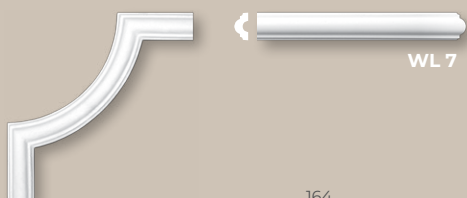
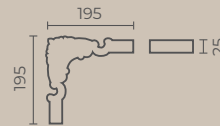

WL 7

STANDARD

WL 7-4

*kombinuje se sa zidnom lajsnom **WL 7**

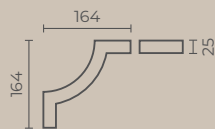

WL 11

STANDARD

WL 11-4 R

*kombinuje se sa zidnom lajsnom **WL 11**

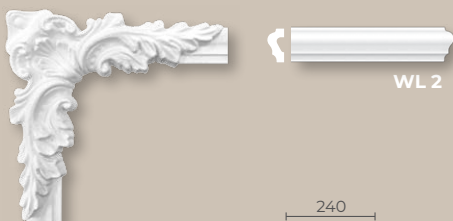
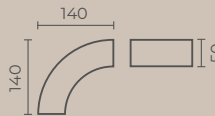

WL 2

STANDARD

WL 202

*kombinuje se sa zidnom lajsnom **WL 2**

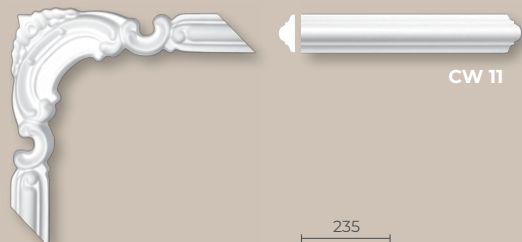
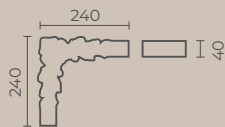

CW 11

(M)

PROFESSIONAL

Z 101

*kombinuje se sa zidnom lajsnom **CW 11**

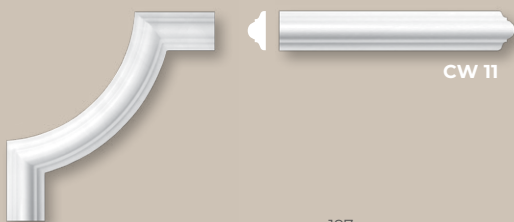
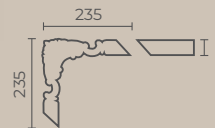

CW 11

PROFESSIONAL

BW 11

*kombinuje se sa zidnom lajsnom **CW 11**

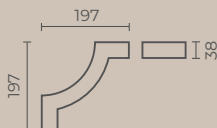

Z 10

(M)

PROFESSIONAL

Z 104

*kombinuje se sa zidnom lajsnom **Z 10**



OTPORNOST NA MEHANIČKA OŠTEĆENJA



FARBANJE BOJOM NA BAZI VODE



JEDNOSTAVNA MONTAŽA

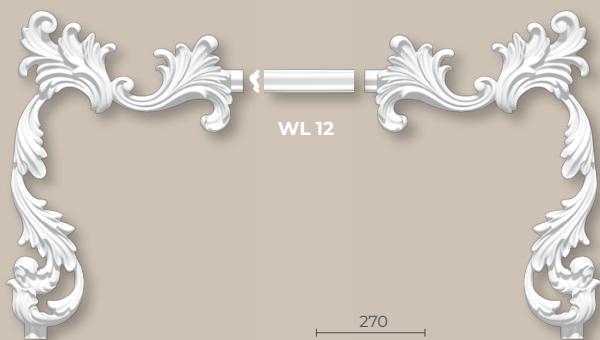

STANDARD

WL 120

*kombinuje se sa zidnom lajsnom **WL 12**



STANDARD

WL 201

*kombinuje se sa zidnom lajsnom **WL 2**

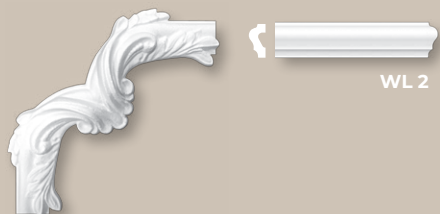

STANDARD

WL 203

*kombinuje se sa zidnom lajsnom **WL 2**



ORNAMENT UGLOVI



STANDARD

O1

PU

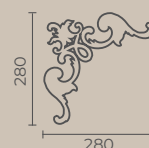

STANDARD

O2

PU

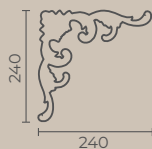

STANDARD

O3

PU

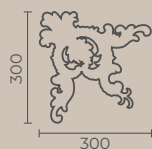

STANDARD

O4

PU

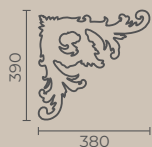

STANDARD

O5

PU



FARBANJE BOJOM NA BAZI VODE



JEDNOSTAVNA MONTAŽA

ZIDNI PANELI

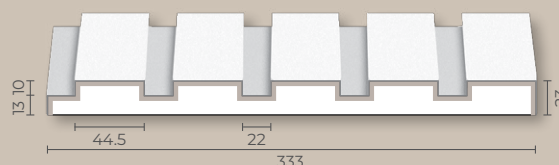

STANDARD

FLAT

L 1000 mm / L 2500 mm

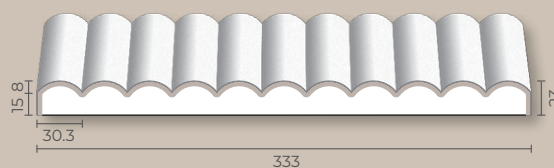

STANDARD

BENDS

L 1000 mm / L 2500 mm

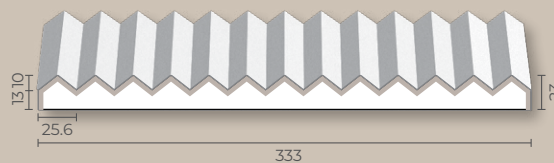

STANDARD

CIK-CAK

L 1000 mm / L 2500 mm

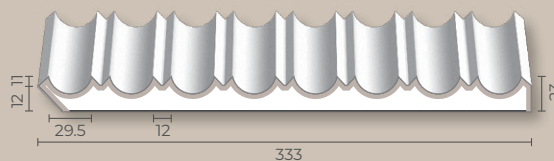

STANDARD

VALE

L 1000 mm / L 2500 mm



NAPOMENA: Ugradnja zidnih panela zahteva idealno ravnu površinu zida

EPS/S EKSPANDIRANI POLISTIREN SA ZAŠTITNIM SLOJEM

OTPORNOST NA VLAGU

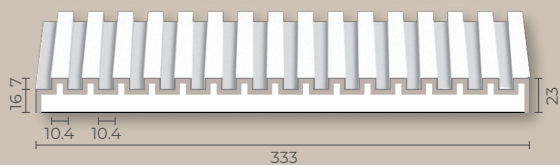

STANDARD

RIBS

L 1000 mm / L 2500 mm

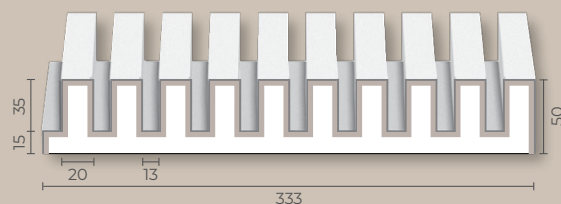

STANDARD

RIBS M

L 2800 mm

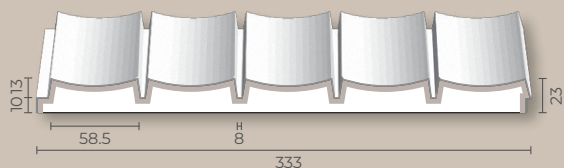

STANDARD

MODERN

L 2500 mm

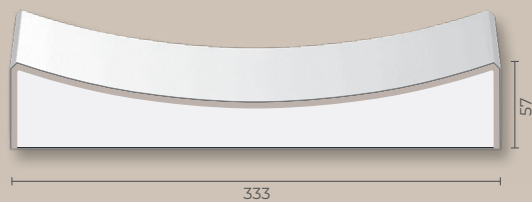

STANDARD

CAVETTO

L 2800 mm

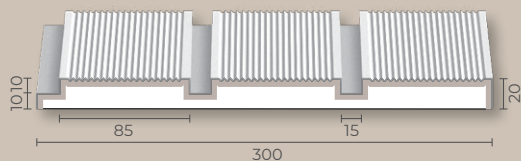

STANDARD

DEKING

L 2500 mm

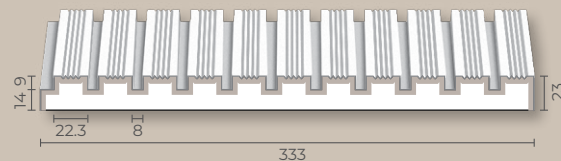

STANDARD

LINES

L 1000 mm / L 2500 mm

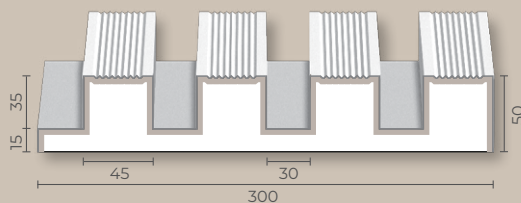

STANDARD

LINES M

L 2800 mm

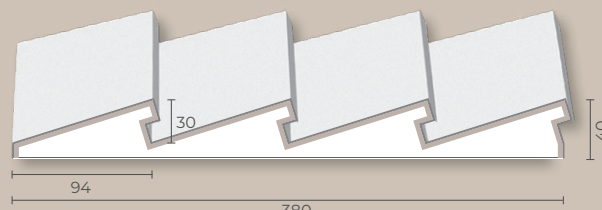

STANDARD

SLASH

L 2500 mm

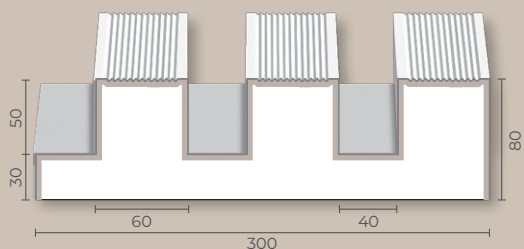

STANDARD

LINES XL

L 2800 mm



ZAVRŠNA LAJSNA ZA ZIDNE PANELE



STANDARD

ZA 40

L 2500 mm

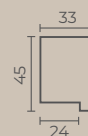

NAPOMENA: Ugradnja zidnih panela zahteva idealno ravnu površinu zida



OTPORNOST NA MEHANIČKA OŠTEĆENJA



FARBANJE BOJOM NA BAZI VODE



JEDNOSTAVNA MONTAŽA

ZIDNI PANELI **PROFESSIONAL**

(M)



PROFESSIONAL

LATTE S

L 2600 mm



(M)



PROFESSIONAL

LATTE L

L 2600 mm



(M)

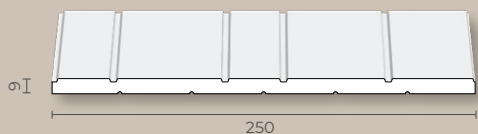

PROFESSIONAL

LATTE MIX

L 2600 mm



(M)

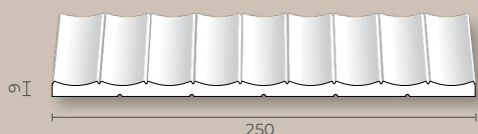

PROFESSIONAL

MEZZALUNA S

L 2600 mm



(M)



PROFESSIONAL

MEZZALUNA L

L 2600 mm



ZAVRŠNE LAJSNE ZA **PROFESSIONAL** ZIDNE PANELE

(M)



WL 10

L 2000 mm



(M)



FL 11 P

L 2000 mm



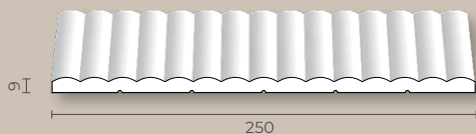

PROFESSIONAL

CANOPÉE S

L 2600 mm

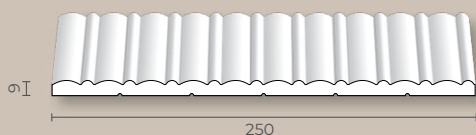

PROFESSIONAL

CANOPÉE MIX

L 2600 mm

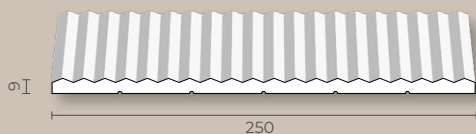

PROFESSIONAL

PLISSÉ S

L 2600 mm

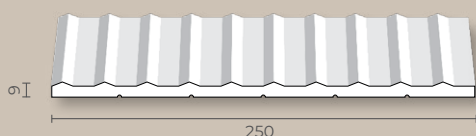

PROFESSIONAL

PLISSÉ L

L 2600 mm

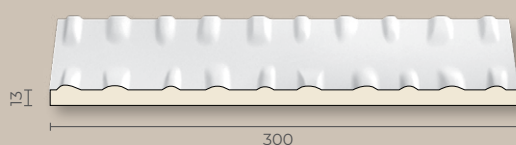

PROFESSIONAL

BOHEMIA

L 2000 mm



OTPORNOST NA VLAGU

FARBANJE BOJOM NA BAZI VODE

JEDNOSTAVNA MONTAŽA

ZAVRŠNE LAJSNE ZA PROFESSIONAL ZIDNE PANELE



WL 13

L 2000 mm



WL 14

L 2000 mm



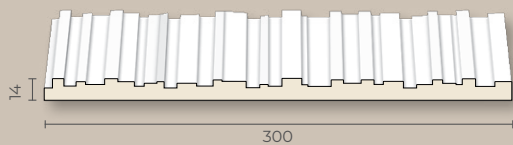

PROFESSIONAL

ALLEGRETTO

L 2000 mm



(M)

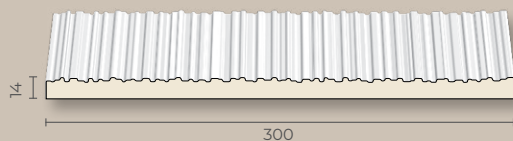

PROFESSIONAL

ALLEGRETTINO

L 2000 mm



(M)

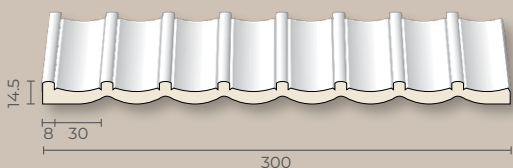

PROFESSIONAL

DORIQUE

L 2000 mm



(M)

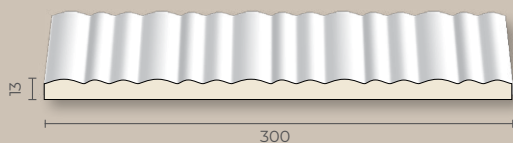

PROFESSIONAL

CALANDO

L 2000 mm



(M)

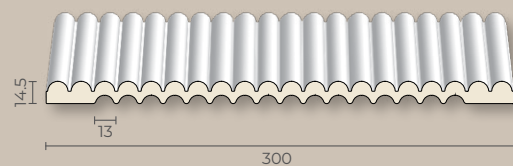

PROFESSIONAL

CANELÉ S

L 2000 mm



(M)

ZAVRŠNE LAJSNE ZA PROFESSIONAL ZIDNE PANELE

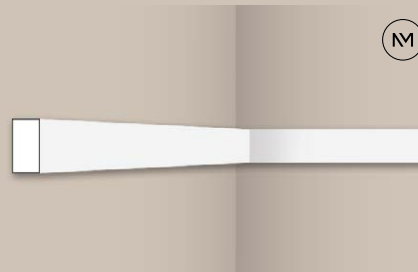

(M)

FL 15

L 2000 mm

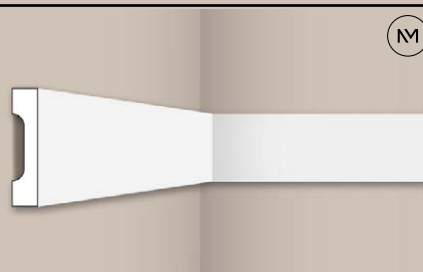

(M)

WD 2

L 2000 mm



(M)

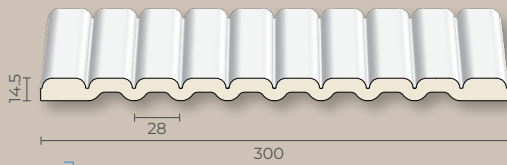

PROFESSIONAL

CANELÉ L

L 2000 mm

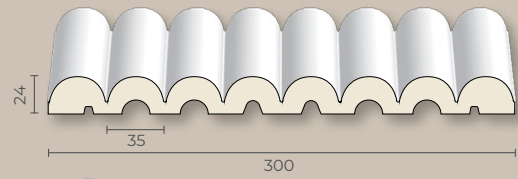

PROFESSIONAL

CANELÉ XL

L 2000 mm



(M)

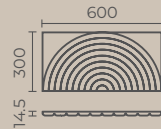

PROFESSIONAL

CANELÉ R L

*kombinuje se
sa zidnim panelom **CANELÉ L**



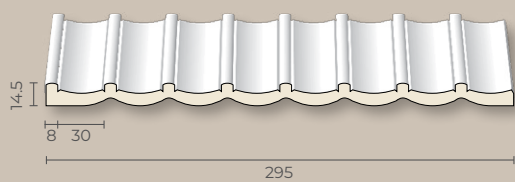

PROFESSIONAL

DORIQUE FLEX

L 2000 mm



M

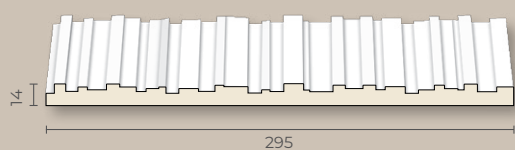

PROFESSIONAL

ALLEGRETTO FLEX

L 2000 mm

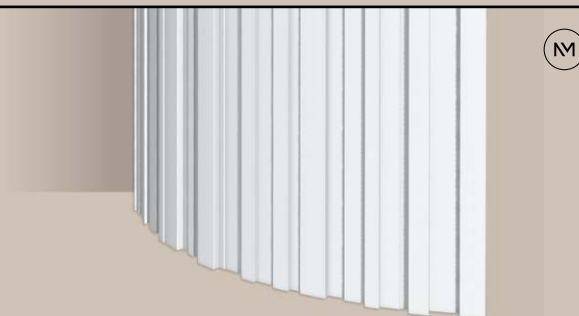

M

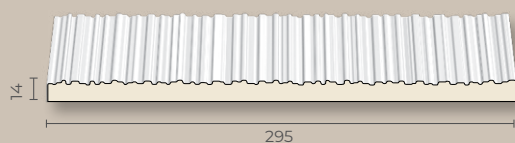

PROFESSIONAL

ALLEGRETTINO FLEX

L 2000 mm

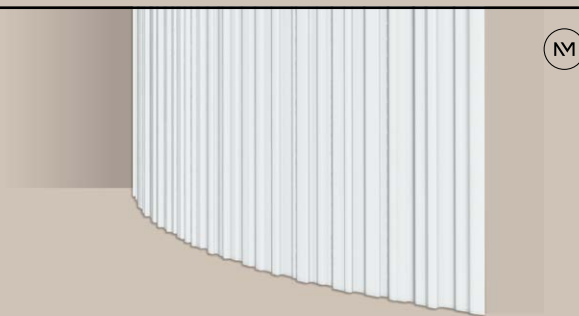

M

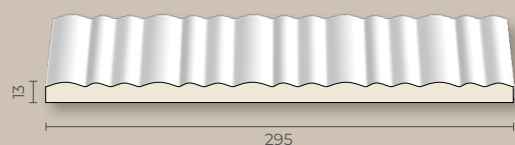

PROFESSIONAL

CALANDO FLEX

L 2000 mm

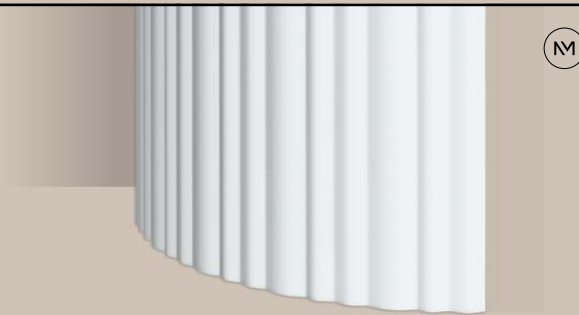

M

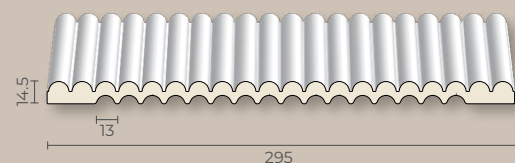

PROFESSIONAL

CANELÉ S FLEX

L 2000 mm

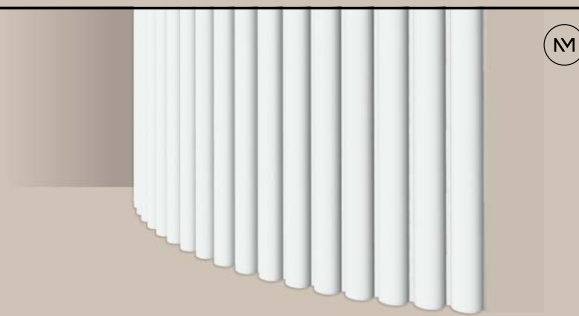

M

SMER SAVIJANJA PANELA NA PLAFONU, ZIDU I PODU

PANEL	MIN. RADIJUS
ALLEGRETTO FLEX	20 cm
CALANDO FLEX	20 cm
DORIQUE FLEX	20 cm
CANELÉ S FLEX	20 cm
CANELÉ L FLEX	20 cm
CANELÉ XL FLEX	20 cm

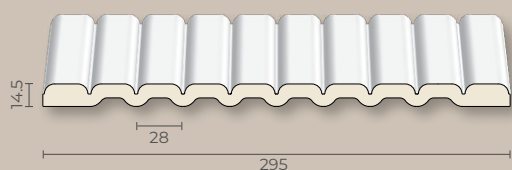
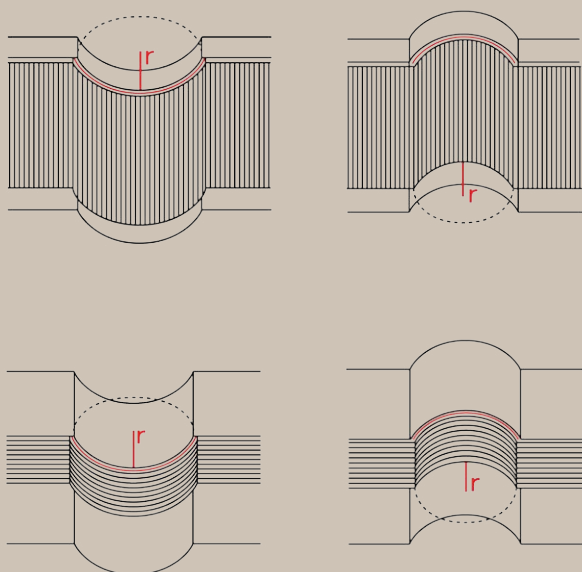

PROFESSIONAL

CANELÉ L FLEX

L 2000 mm

PU FLEX

(M)

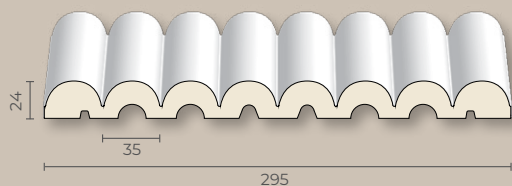

PROFESSIONAL

CANELÉ XL FLEX

L 2000 mm

PU FLEX

(M)



FARBANJE BOJOM NA BAZI VODE



JEDNOSTAVNA MONTAŽA

FLEX FLEKSIBILAN PROIZVOD

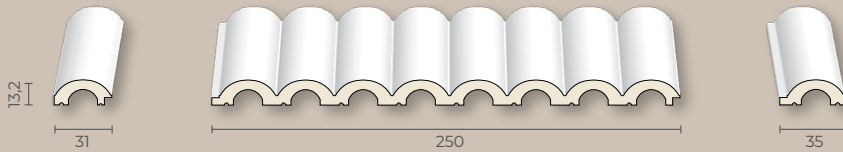

PROFESSIONAL

DUNA L (WP 001 L)

LEVI VERTIKALNI ZAVRŠETAK
L 2700 mm

DUNA (WP001)

ZIDNI PANEL
L 2700 mm

DUNA R (WP 001 R)

DESNI VERTIKALNI ZAVRŠETAK
L 2700 mm

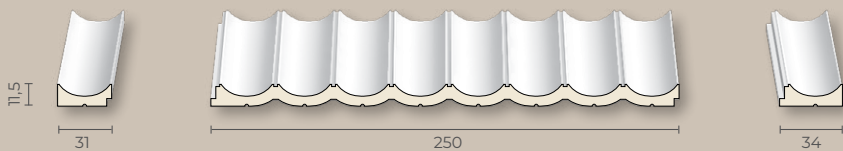

PROFESSIONAL

LUMIO L (WP 002 L)

LEVI VERTIKALNI ZAVRŠETAK
L 2700 mm

LUMIO (WP002)

ZIDNI PANEL
L 2700 mm

LUMIO R (WP 002 R)

DESNI VERTIKALNI ZAVRŠETAK
L 2700 mm

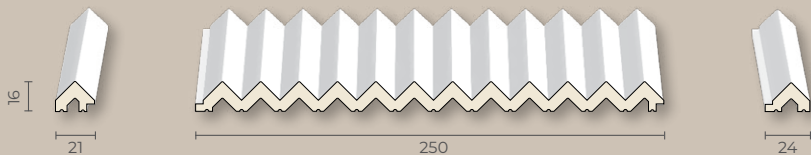

PROFESSIONAL

VIVID L (WP 003 L)

LEVI VERTIKALNI ZAVRŠETAK
L 2700 mm

VIVID (WP003)

ZIDNI PANEL
L 2700 mm

VIVID R (WP 003 R)

DESNI VERTIKALNI ZAVRŠETAK
L 2700 mm

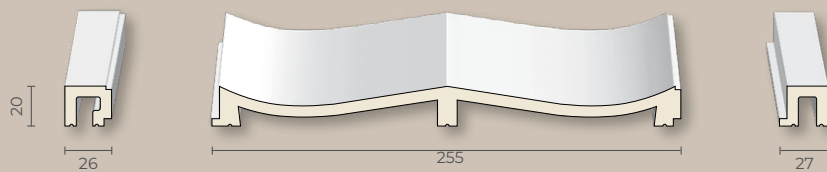

PROFESSIONAL

ETERNO L (WP 004 L)

LEVI VERTIKALNI ZAVRŠETAK
L 2700 mm

ETERNO (WP004)

ZIDNI PANEL
L 2700 mm

ETERNO R (WP 004 R)

DESNI VERTIKALNI ZAVRŠETAK
L 2700 mm



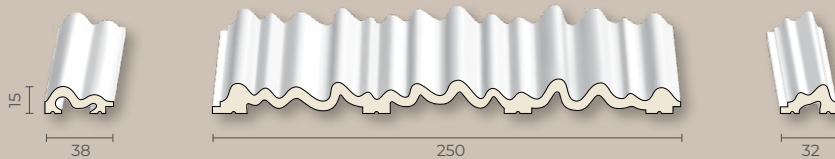

PROFESSIONAL

ARIA L (WP 005 L)

LEVI VERTIKALNI ZAVRŠETAK
L 2700 mm

ARIA (WP005)

ZIDNI PANEL
L 2700 mm

ARIA R (WP 005 R)

DESNI VERTIKALNI ZAVRŠETAK
L 2700 mm



FARBANJE BOJOM NA BAZI VODE



JEDNOSTAVNA MONTAŽA



(M)

PROFESSIONAL

ARC S

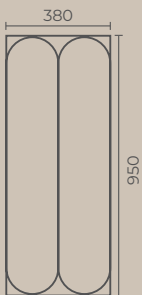
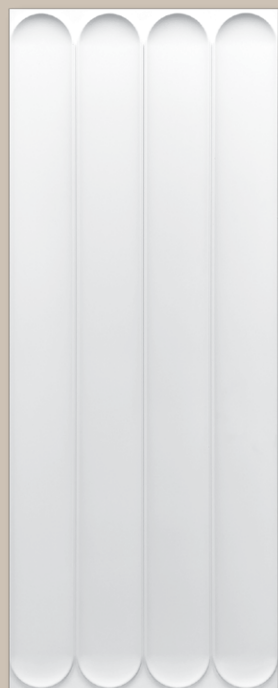

(M)

PROFESSIONAL

ARC L



KOMPLEMENTARNE LAJSNE
ZA ZIDNE PANELE

(M)



WL 13

L 2000 mm



(M)



WL 14

L 2000 mm



(M)

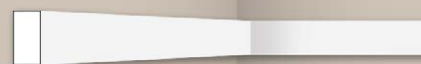

FL 15

L 2000 mm



(M)



FL 11 P

L 2000 mm



(M)



WL 10

L 2000 mm



(M)



WD 2

L 2000 mm





ZIDNI PANELI **PROFESSIONAL**



(M)

PROFESSIONAL

WING



(M)

PROFESSIONAL

CORAL

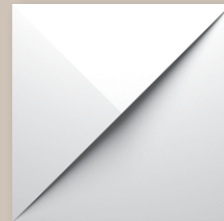
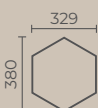

(M)

PROFESSIONAL

PUZZLE

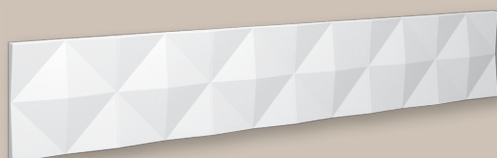
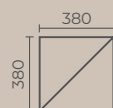

(M)

PROFESSIONAL

PYRAMID

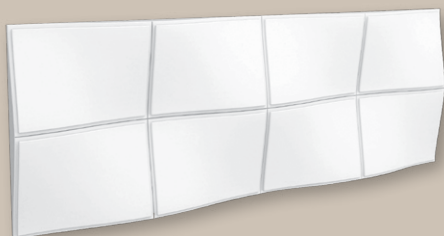

(M)

PROFESSIONAL

BUMP



(M)

PROFESSIONAL

WAVE

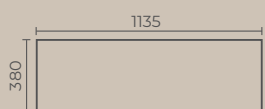

ZIDNI PANELI SA RAMOM **STANDARD**

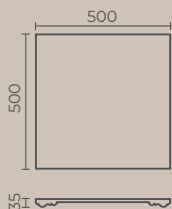

STANDARD

CLASSIC 50

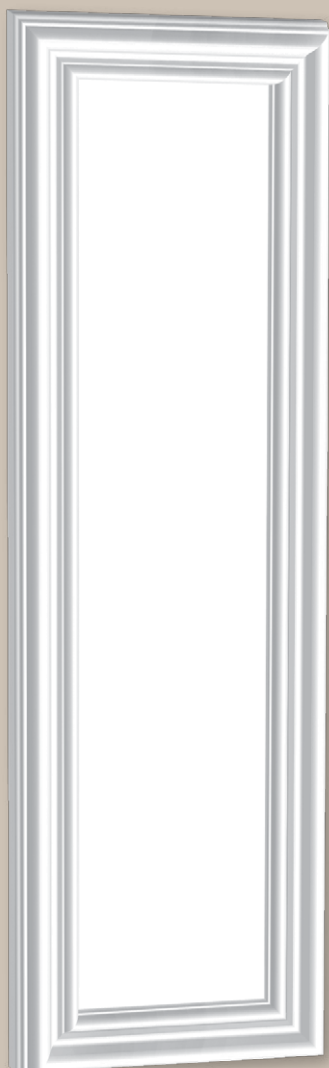

STANDARD

CLASSIC 150











3D ZIDNE OBLOGE



**FALA
WHITE**

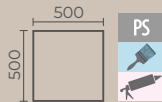

**LOTOS
WHITE**

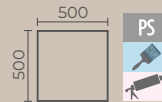

**PLED
WHITE**

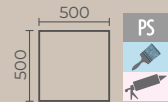

**KRATER
WHITE**

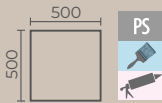

**TABS
WHITE**

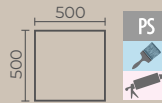

STANDARD
FALA SAND

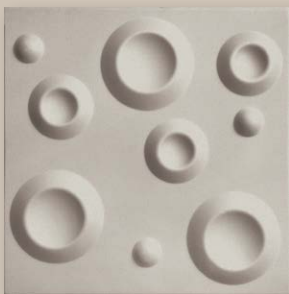

STANDARD
KRATER SAND





PILLOW 500 500 EPS



WIND 500 500 EPS



ABSTRACT 500 500 EPS

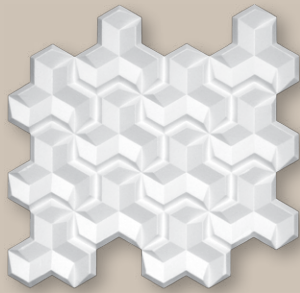

BUMERANG 507 485 EPS

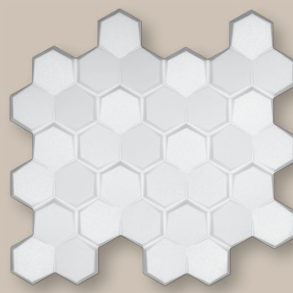

HONEYCOMB 507 485 EPS



3D ZIDNE OBLOGE



**GLATKA
CIGLA**

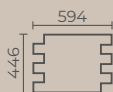

**STARA
CIGLA**

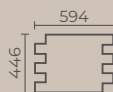

**RUSTIC
WOOD**

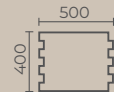

**UGAO
ZA STARU
CIGLU
UNUTRAŠNJI**



**UGAO
ZA STARU
CIGLU
SPOLJAŠNJI**



STYRO STONE



SOFT

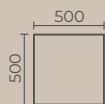

SOLID



AMBIENTE



STANDARD

SAND



PLAFONSKE OBLOGE



MODEL 1



MODEL 2



MODEL 3

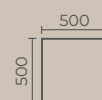

MODEL 4



MODEL 5



MODEL 6

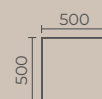

MODEL 7



MODEL 8





KELENPUTZ



PARIS



BERLIN

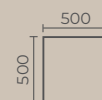

NORMA

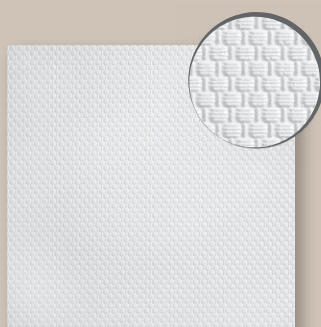

PRAG



IZOLACIONE FOLIJE



IZOTAP

10000x500x4 mm



ALUTHERM

5000x500x3 mm



PLUTA U ROLNI

8000x500x2 mm



PLUTA U ROLNI

5000x500x4 mm

ROZETE



M



PROFESSIONAL

R 1



PU



STANDARD

RO 1

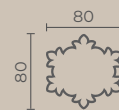

PU



STANDARD

RO 2

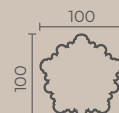

PU



PU POLIURETAN



(M)

PROFESSIONAL

R 6

415



(M)

PROFESSIONAL

R 9

530



(M)

PROFESSIONAL

R 15

555



(M)

PROFESSIONAL

R 12

825



(M)

PROFESSIONAL

R 24

765



(M)

PROFESSIONAL

R 25

965





K 6



K 8



K 9



**K 10
(ROSA)**



K 11 N



**K 13
(MIRA)**



K 14



**K 17
(PRISCA)**

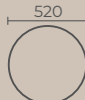

**K 18
(FLORA)**



**K 19
(IRA)**



GABI



SARA



* Kombinuje se sa ukrasnom lajsnom LISA

* Kombinuje se sa ukrasnom lajsnom INES



R 17

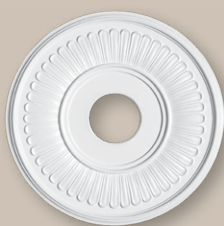

R 40



R 20



R 30

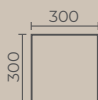

CS 3



C 27



FARBANJE BOJOM NA BAZI VODE



JEDNOSTAVNA MONTAŽA

STUBOVI, PILASTERI I UKRASI

UKRASI

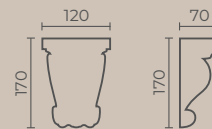

ALINA

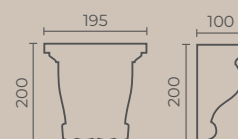

MELINA



STUBOVI

D1 / HS 22K / HS 22F

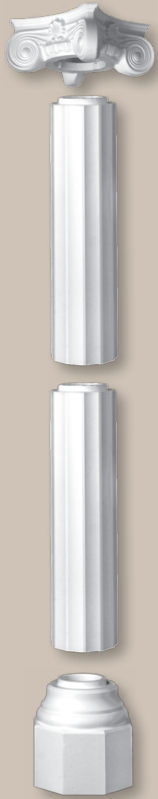

KAPITEL - D1

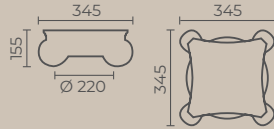

STUB - HS 22K

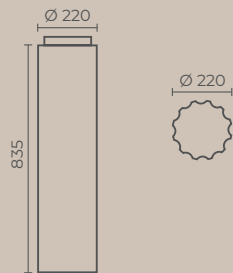

STOPA - HS 22F

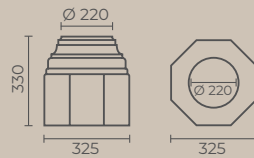

PILASTERI

HKP 15G / HP 15 / HFP 15

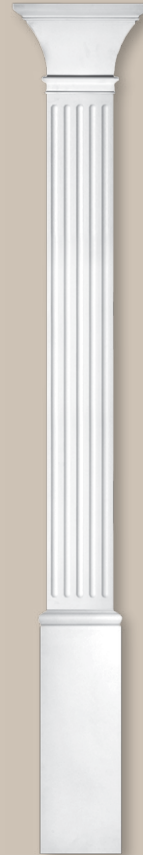

KAPITEL - HKP 15G

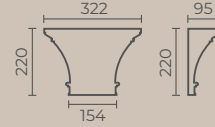

PILASTER - HP 15

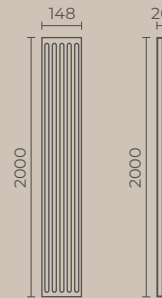

BAZA - HFP 15

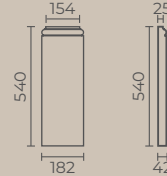

D2 / HS 22R / HS 22F

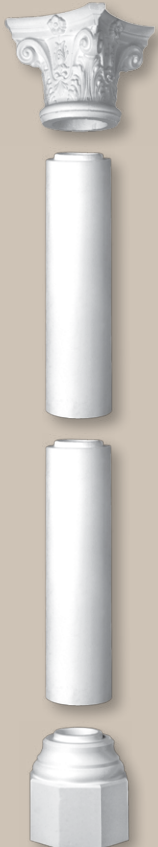

KAPITEL - D2

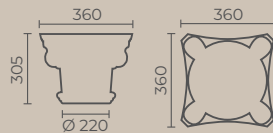

STUB - HS 22R

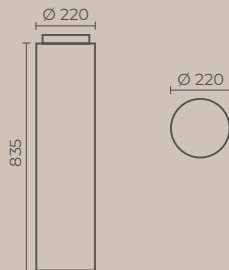

STOPA - HS 22F

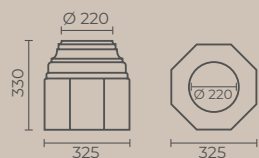

HKP 15D / HP 15 / HFP 15



KAPITEL - HKP 15D

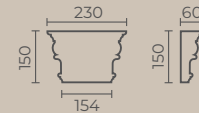

PILASTER - HP 15



BAZA - HFP 15

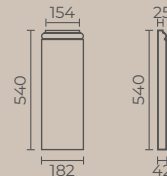

RUSTIK DIZAJN



STARE GREDE

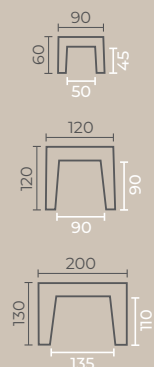

SVETLA

L 2000 mm / L 4000 mm

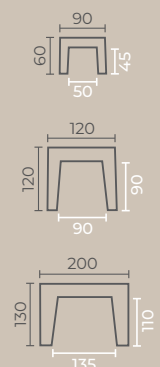

TAMNA

L 2000 mm / L 4000 mm

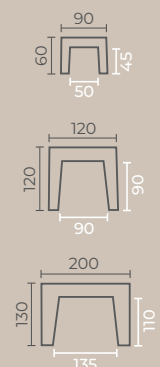

BELA

L 2000 mm / L 4000 mm



NAPOMENA: Dimenzije gotovog proizvoda se mogu razlikovati

PU POLIURETAN

DEKO DASKE



SVETLI HRAST

L 2600 mm



KONZOLE

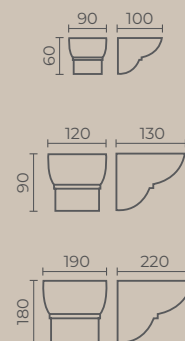

SVETLA



TAMNI HRAST

L 2600 mm

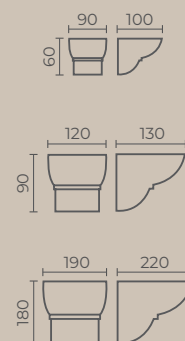

TAMNA

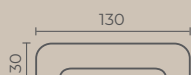
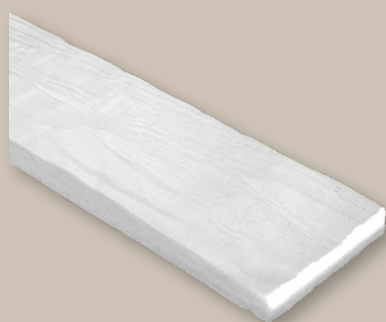

BELA

L 2600 mm

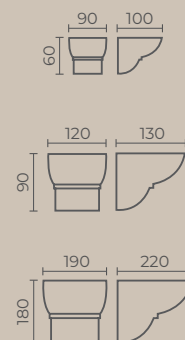

BELA



DEKORATIVNA TRAKA ZA SPOJEVE

Š 40 mm
D 950 mm

NAPOMENA: Dimenzije gotovog proizvoda se mogu razlikovati



OTPORNOST NA VLAGU



FARBANJE BOJOM NA BAZI VODE



JEDNOSTAVNA MONTAŽA

IMITACIJA KAMINA

- Imaju dekorativnu funkciju i ne emituju toplotu
- Nisu predviđeni za montažu ložišta u neposrednoj blizini
- Isporučuju se u beloj boji, u delovima koje sami sklapate
 - Jednostavna montaža i demontaža
- U slučaju montaže električnog ložišta - deaktivirati grejanje

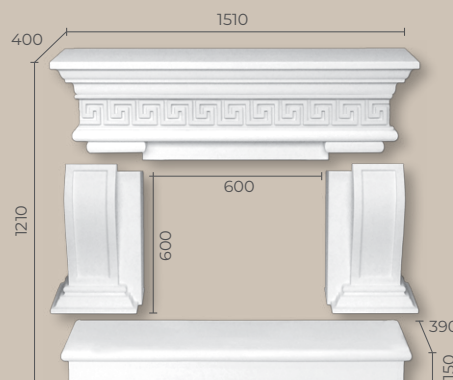

STANDARD

ATINA

V 1210 mm

Š 1510 mm

D 390 mm

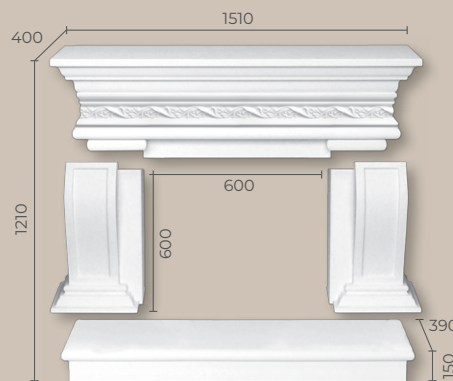

STANDARD

PARIS

V 1210 mm

Š 1510 mm

D 390 mm



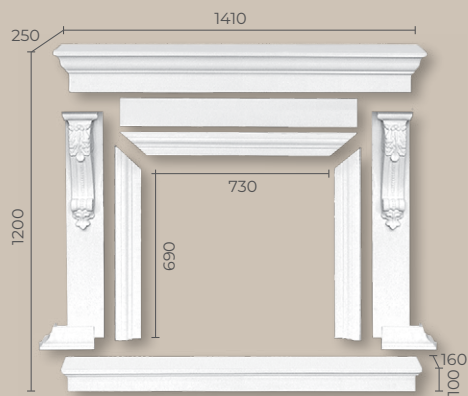

STANDARD

WIEN

V 1200 mm

Š 1410 mm

D 160 mm

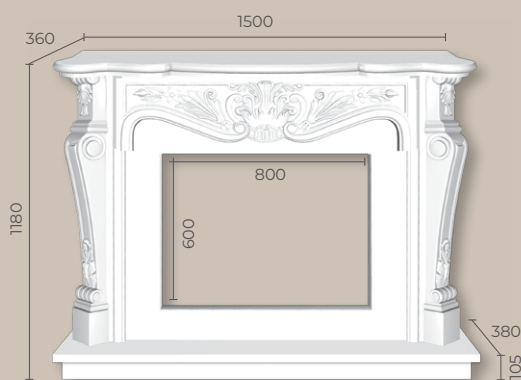

STANDARD

VERSAJ

V 1180 mm

Š 1500 mm

D 380 mm



STANDARD

LION

V 1200 mm

Š 1670 mm

D 135 mm



ŽARDINJERE

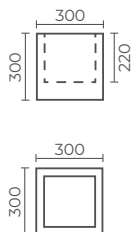
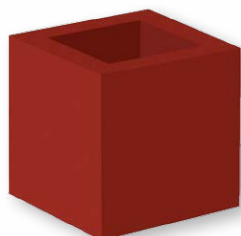

STANDARD

STANDARD 30

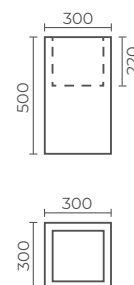
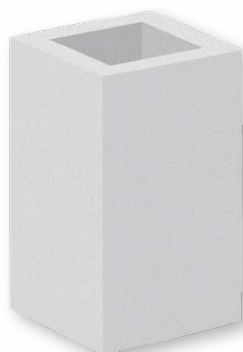

STANDARD

STANDARD 50

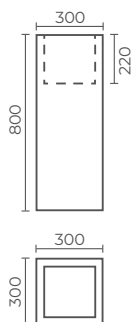

STANDARD

STANDARD 80

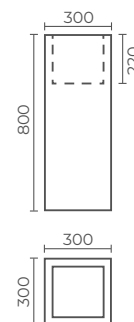

STANDARD

LUX 80

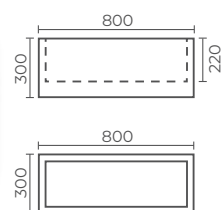

STANDARD

LUX H30



STANDARDNE
BOJE







3D ELEMENTI

IZRADA ELEMENATA PO DOSTAVLJENIM 3D MODELIMA









LEPKOVI I PRIBOR ZA MONTAŽU

FASADNI DEKORATIVNI ELEMENTI



KOMPOZITNI MALTER 1,4 kg

NAMENA:
Sanacija oštećenja
na fasadnim elementima

SADRŽAJ:
· vodorastvorivo vezivo
· kvarcni pesak



SET ZA ZAVRŠNU OBRADU SPOJA FASADNIH LAJSNI

NAMENA:
Završna obrada spoja
fasadnih lajsni

SADRŽAJ:
· kompozitni malter
· emulzija sa četkom
· kvarcni pesak



PU-FIX 300 ml

NAMENA:
Lepljenje spojeva
fasadnih profila



STIL-FIX 1 290 ml

NAMENA:
Lepljenje spojeva
na fasadnim lajsnama

DEKORATIVNI ELEMENTI ZA ENTERIJER



DECOFIT 1,6 kg

PROSEČNA POTROŠNJA:
300 g/m²

NAMENA:
· plafonske i zidne obloge
od polistirena
· dekorativne lajsne
od polistirena
· izolacione tapete



DECOFIT 4 kg

PROSEČNA POTROŠNJA:
300 g/m²

NAMENA:
· plafonske i zidne obloge
od polistirena
· dekorativne lajsne
od polistirena
· izolacione tapete



DECOFIT 310 ml

PROSEČNA POTROŠNJA:
310 ml/10-20 m dekorativnih
lajсни

NAMENA:

- plafonske i zidne obloge
od polistirena
- dekorativne lajsne
od polistirena
- izolacione tapete
- rozete



DECOFIT JUMBO 290 ml

PROSEČNA POTROŠNJA:
290 ml/4 m dekorativne grede

NAMENA:

- dekorativne grede, daske
i konzole
- dekorativni elementi
za enterijer od poliuretana
i polistirena visoke gustine



ADEFIX® 310 ml

PROSEČNA POTROŠNJA:
310ml/ 5-10m dekorativnih lajsni

NAMENA:

- lepljenje stiroporskih lajsni
- finalno popunjavanje i obrada
spojeva



STIL-FIX 1 290 ml

PROSEČNA POTROŠNJA:
290ml/ 5-10m dekorativnih lajsni

NAMENA:

- lepljenje lajsni od polistirena visoke
gustine (HDPS), poliuretana (PU), PU
Flex lajsni, stiropora
- lepljenje dekorativnih elemenata



STIL-CONNECT 2 310 ml

NAMENA:

- lepljenje spojeva na HDPS, PU,
PU Flex i stiroporskim lajsnama
- lepljenje spojeva na stiroporskim
lajsnama
- za lepljenje spojeva lajsni od
HDPS, PU i PU Flex koristi se
kombinacija lepkova
STIL-CONNECT 2 i STIL-FINISH 3



STIL-FINISH 3 310 ml

NAMENA:

- ispunjena pri lepljenju HDPS, PU,
PU Flex i stiroporskih lajsni
- kompletno lepljenje stiroporskih
lajсни
- za lepljenje spojeva lajsni od
HDPS, PU i PU Flex koristi se
kombinacija lepkova
STIL-CONNECT 2 i STIL-FINISH 3

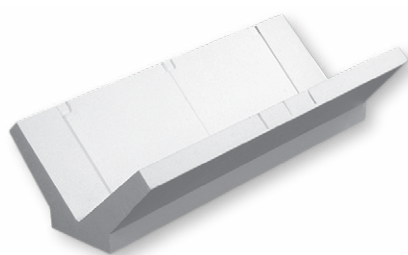

ŠABLON S

NAMENA:
Sečenje lajsni
pod uglom

DIMENZIJE:
440 x 110 x 200 mm



ŠABLON ZA GEROVANJE

NAMENA:
Sečenje lajsni pod uglom
od 45° i 22,5°
Za kreiranje ravnih rezova

DIMENZIJE:
400 x 255 x 280 mm

UPUTSTVO ZA MONTAŽU FASADNIH PROFILA

MONTAŽA FASADNIH PROFILA NA ZID

Fasadni profili se lepe CEMENTNIM LEPKOM ZA STIROPOR ili PU PENOM. Pre nego što se započne sa lepljenjem, neophodno je da podloga bude čista, suva i čvrsta.

1_SEČENJE FASADNOG PROFILA NA MERU



Sečenje fasadnog profila na meru pomoću električnog cirkulara (preporuka: DEWALT DWS 780)

2a_LEPLJENJE FASADNOG PROFILA CEMENTNIM LEPKOM

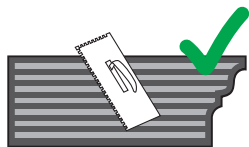

Cementni lepak naneti nazubljenom gletaricom na fasadni profil po celoj površini koja se lepi

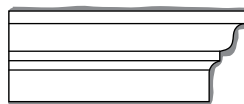

Lepak naneti u debljem sloju u širini 0-2 cm od ivice fasadnog profila da bi se sprečilo prodor vode

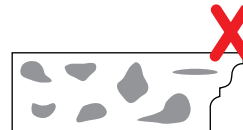

Nepravilno nanošenje cementnog lepka na fasadni profil

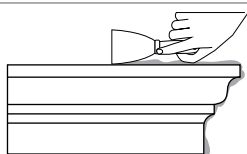

Fasadni profil prisloniti na mesto lepljenja i dovesti u željeni položaj. Višak lepka ukloniti špahtlom dok je svež

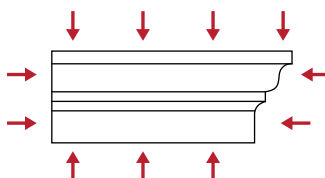

Svi spojevi fasadnog profila i zida moraju biti zatvoreni!

2b_LEPLJENJE FASADNOG PROFILA PU PENOM

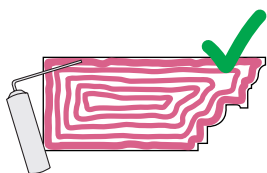

PU penu naneti kružno pomoću aplikatora na fasadni profil po celoj površini koja se lepi

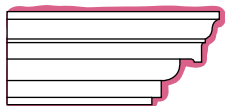

PU penu naneti u debljem sloju na širini 0-2 cm od ivice fasadnog profila da bi se sprečilo prodor vode

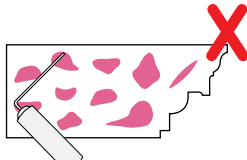

Nepravilno nanošenje PU pene na fasadni profil

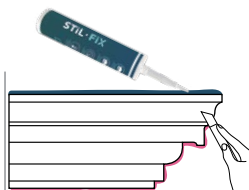

Kada se osuši, višak PU pene odstraniti skalpelom. Zaptivanje spoja između zida i lajsne vrši se lepkom STIL-FIX

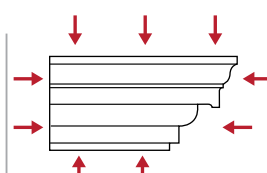

Svi spojevi fasadnog profila i zida moraju biti zatvoreni!

SPAJANJE FASADNIH PROFILA

Za spajanje dva profila koristi se kombinacija lepkova STIL-FIX i PU-FIX.

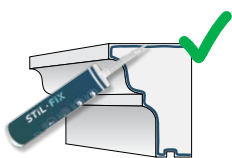

Lepak STIL-FIX 1 naneti linijski na profil lajsne, na udaljenosti 1-2 mm od prednje ivice, prateći profil lajsne

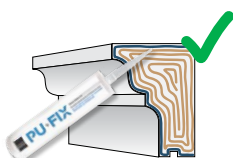

Lepak PU-FIX naneti linijski na profil lajsne, na udaljenosti 5 mm od prednje ivice, kao i po celoj površini predviđenoj za lepljenje

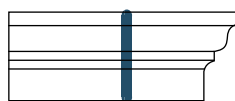

Sastaviti profile. Nakon sastavljanja, deo lepka STIL-FIX 1 treba da se pojavi na celoj liniji spoja

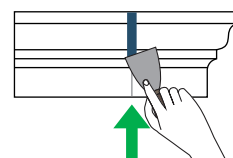

Lepak koji se pojavi na liniji spoja odstraniti špahtlom dok je svež, pokretom od donje ivice ka gornjoj, tako da se višak zadržava na šahtli

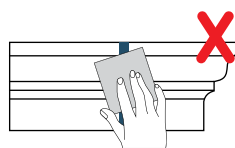
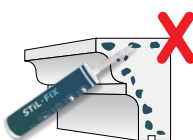

Lepak STIL-FIX 1 se ne može šmirglati!



Farbati visoko-paropropusnim fasadnim bojama (silikonskim ili silikonsko-silikatnim)

*Vreme sušenja STIL-FIX 1 lepka: 24 h

UPUTSTVO ZA MONTAŽU PROZORSKIH KLUPICA

1_MERENJE DIMENZIJA
PODLOGE

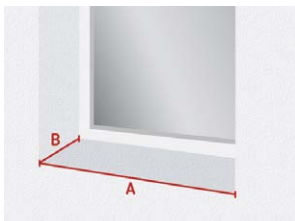

2_OZNAČAVANJE LINIJE
SEČENJA PROZORSKE
KLUPICE

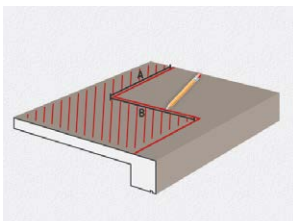

3_SEČENJE
PROZORSKE KLUPICE

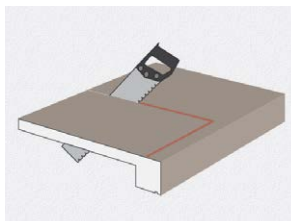

4_NANOŠENJE LEPKA
ZA STIROPOR
NA PODLOGU



5_NANOŠENJE LEPKA
ZA STIROPOR
NA POLEDINU KLUPICE

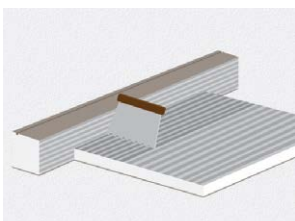

6_LEPLJENJE KLUPICE
NA PODLOGU I ZAPTIVANJE
MONTAŽNOM GIT MASOM

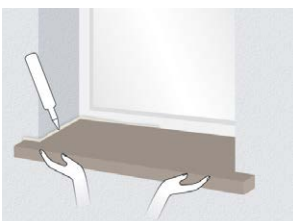

7_LEPLJENJE ZAVRŠETAKA
NA KRAJEVE KLUPICA
POMOĆU MONTAŽNOG LEPKA



8_FARBANJE
VISOKO-PAROPROPUSNOM
FASADNOM BOJOM



Fasadne elemente skladištiti u suvim prostorijama u originalnoj ambalaži.
Montažu elemenata izvoditi u suvim uslovima na temperaturi od +8 °C do +30 °C.

UPUTSTVO ZA GEROVANJE FASADNIH LAJSNI

1_OBELEŽAVANJE
LINIJA SEČENJA

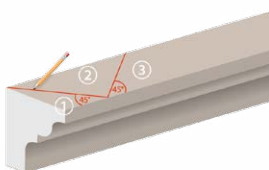

2_SEČENJE FASADNE LAJSNE

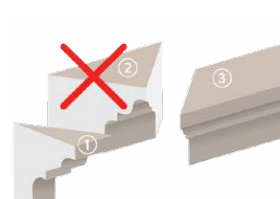
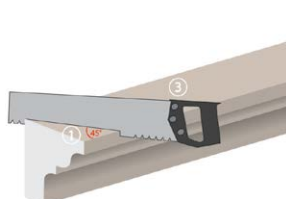

3_SPAJANJE FASADNE LAJSNE

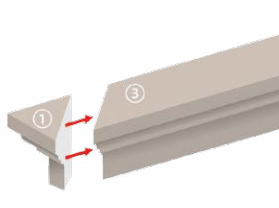
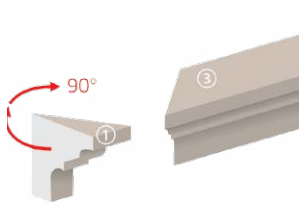

FINALNI IZGLED
GEROVANE FASADNE LAJSNE

UPUTSTVO ZA MONTAŽU NUT PROFILA

PRIKAZ SLOJEVA TERMOIZOLACIJE SA UGRAĐENIM NUT PROFILOM

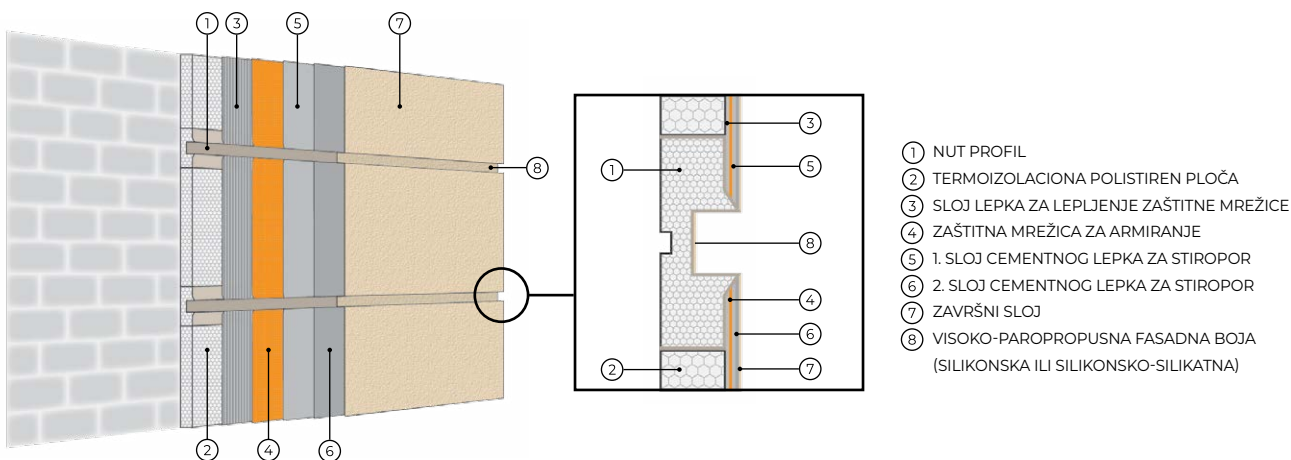

- ① NUT PROFIL
- ② TERMOIZOLACIONA POLISTIREN PLOČA
- ③ SLOJ LEPKA ZA LEPLJENJE ZAŠTITNE MREŽICE
- ④ ZAŠTITNA MREŽICA ZA ARMIRANJE
- ⑤ 1. SLOJ CEMENTNOG LEPKA ZA STIROPOR
- ⑥ 2. SLOJ CEMENTNOG LEPKA ZA STIROPOR
- ⑦ ZAVRŠNI SLOJ
- ⑧ VISOKO-PAROPROPUSNA FASADNA BOJA (SILIKONSKA ILI SILIKONSKO-SILIKATNA)

1_SEČENJE PROFILA NA MERU



Najbolji rez postiže se rezanjem pomoću električnog cirkulara (preporuka: DEWALT DWS 780)

2_LEPLJENJE NUT PROFILA NA ZIDNU POVRŠINU

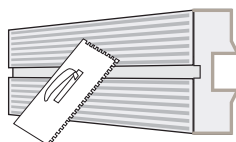

Lepak naneti nazubljenom gletaricom

3_SPAJANJE DVA NUT PROFILA

Za spajanje dva nut profila koristi se STIL-FIX 1 lepak.

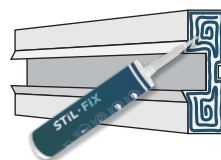

STIL-FIX 1 lepak naneti linijski po ivici (2 mm od ivice profila), kao i po celoj površini koja se lepi



Sastaviti profile. Nakon sastavljanja, deo lepka treba da se pojavi na celoj liniji spoja

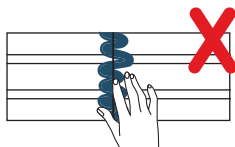

LEPAK SE NE SME RAZMAZIVATI!

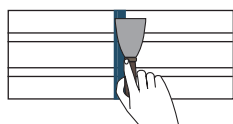

Lepak koji se pojavi na liniji spoja odstraniti špahtlom dok je svež

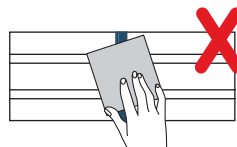

Lepak se NE MOŽE šmirglati!



Vreme sušenja: 24 h

4_POKRIVANJE ZIDNE POVRŠINE I LEPLJENJE ZAŠTITNE MREŽICE ZA ARMIRANJE



Prostor na zidnoj površini između nut profila popuniti termoizolacionom polistiren pločom. Zatim na zidnu površinu zalepiti zaštitnu mrežicu nazubljenom gletaricom

5_NANOŠENJE 1. I 2. SLOJA CEMENTNOG LEPKA ZA STIROPOR

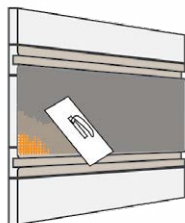

Lepak naneti ravnom gletaricom

6_NANOŠENJE ZAVRŠNOG SLOJA

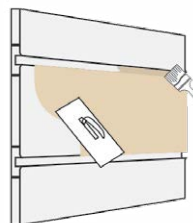

Završni sloj naneti ravnom gletaricom. Farbati visoko-paropropusnim fasadnim bojama (silikonskim ili silikonsko-silikatnim)

Fasadne elemente skladištiti u suvim prostorijama u originalnoj ambalaži. Montažu elemenata izvoditi u suvim uslovima na temperaturi od +8 °C do +30 °C.

UPUTSTVO ZA MONTAŽU FASADNIH PANELA

MONTAŽA FASADNIH PANELA NA ZID

Fasadni paneli se lepe CEMENTNIM LEPKOM ZA STIROPOR ili PU PENOM. Pre nego što se započne sa lepljenjem, neophodno je da podloga bude čista, suva i čvrsta.

1_SEČENJE FASADNOG PANELA NA MERU



Sečenje fasadnog panela na meru pomoću električnog cirkulara (preporuka: DEWALT DWS 780)

2a_LEPLJENJE FASADNOG PANELA CEMENTNIM LEPKOM

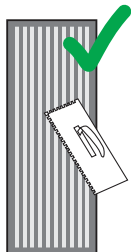

Cementni lepak naneti nazubljenom gletaricom na fasadni panel po celoj površini koja se lepi



Lepak naneti u debljem sloju u širini 0-2 cm od ivice fasadnog panela da bi se sprečio prodor vode iza panela



Nepravilno nanošenje cementnog lepka na fasadni panel

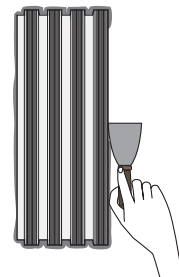

Fasadni panel prisloniti na mesto lepljenja i dovesti u željeni položaj. Višak lepka ukloniti špahtlom dok je svež

2b_LEPLJENJE FASADNOG PANELA PU PENOM

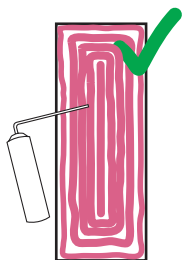

PU penu naneti kružno pomoću aplikatora na fasadni panel po celoj površini koja se lepi, kako bi se sprečio prodor vode iza panela

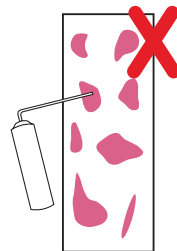
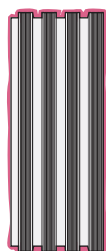

Nepravilno nanošenje PU pene na fasadni panel

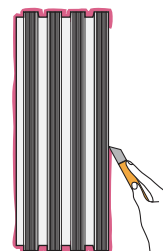

Višak PU pene koja se istisne prilikom lepljenja, kada se osuši, ukloniti skalpelom

SPAJANJE FASADNIH PANELA

Za spajanje dva fasadna panela koristi se STIL-FIX 1 lepak.

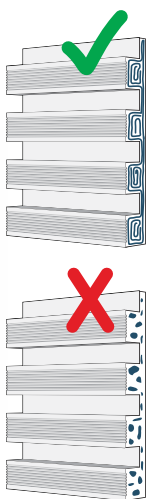

STIL-FIX 1 lepak naneti linijski po ivici (2 mm od ivice profila) kao i po celoj površini koja se lepi



Sastaviti panele. Nakon sastavljanja, deo lepka treba da se pojavi na celoj liniji spoja



LEPAK SE NE SME RAZMAZIVATI!

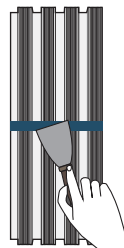

Lepak koji se pojavi na liniji spoja odstraniti špahtlom dok je svež



Lepak se NE MOŽE šmirglati!



Farbati visoko-paropropusnim fasadnim bojama (silikonskim ili silikonsko-silikatnim)

*Vreme sušenja STIL-FIX 1 lepka: 24 h

PROMOTIVNI MATERIJAL

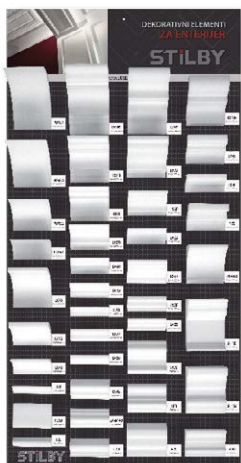

PANO UNUTRAŠNJIH LAJSNI
950x480 mm



PANO SKRIVAČI RASVETE
950x480 mm

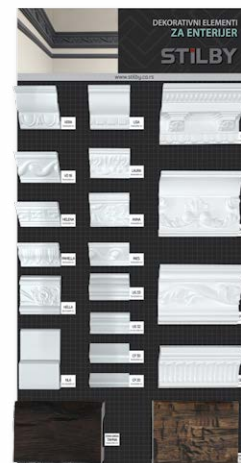

PANO UNUTRAŠNJIH DEKORATIVNIH ELEMENATA
950x480 mm

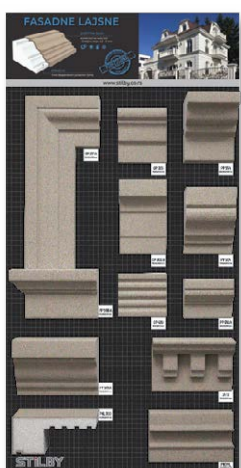

PANO FASADNIH DEKORATIVNIH ELEMENATA
950x480 mm

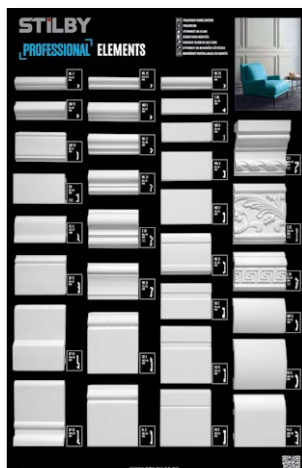

PANO "PROFESSIONAL" ZIDNE I PODNE LAJSNE
950x600 mm



PANO "STANDARD" ZIDNI PANELI
950x850 mm



**PANO FASADNIH
DEKORATIVNIH ELEMENATA**
1000x800 mm

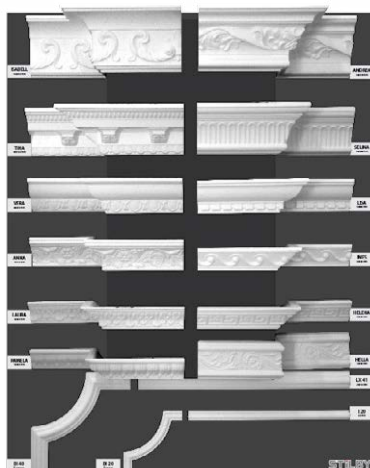

**PANO GRAVIRANIH
UNUTRAŠNJIH LAJSNI**
1000x800 mm

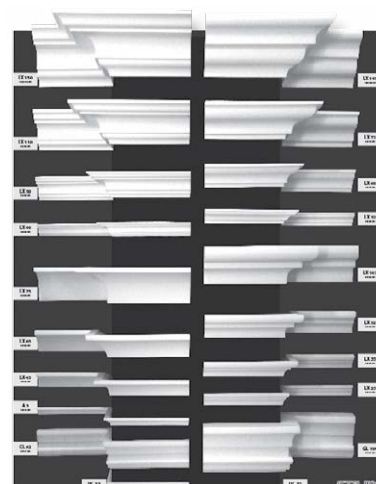

**PANO
UNUTRAŠNJIH LAJSNI**
1000x800 mm

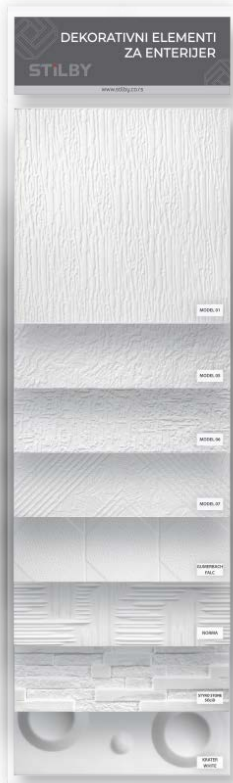

**PLAFONSKE OBLOGE
U FOLIJI**
1700x520 mm



**STALAK
ZA ZIDNE PANELE**
1900x740x400 mm



**STALAK ZA UNUTRAŠNJE
DEKORATIVNE ELEMENTE**
2080x1080x370 mm

SKENIRAJ
ZA CENE



POSETI
WEB SAJT



UPUTSTVA
ZA MONTAŽU



STILBY DOO

- 📍 Lenjinova 120
21470 Bački Petrovac, Srbija
- ☎ +381 21/22 15 188
- ✉ office@stilby.co.rs
- 🌐 www.stilby.co.rs
- 📷 stilby.doo
- 📍 stilby2002